



Lineabeta®



Catalogo
Catalog / Catalogue / Katalog



*A Carlo,
per aver saputo costruire
questo meraviglioso viaggio.*



Offriamo l'opportunità

We offer the
a molti di vivere

opportunity to
un prodotto

experience a product
nato da persone che

created by people
lavorano con creatività

who work creatively
pensando alle esigenze

thinking about the
di tutti

needs of everyone.

Carlo Capitanio
fondatore Lineabeta Spa
founder of Lineabeta Spa

Nous offrons l'opportunité à

Wir bieten die
beaucoup de vivre

Möglichkeit, mit einem
un produit né de personnes

Produkt für Menschen
qui travaillent

zu leben und wir wollen
avec créativité en pensant

dabei kreativ arbeiten.
aux exigences de tous

Carlo Capitanio
fondateur de Lineabeta Spa
gründer der Lineabeta Spa

Storia

They say
di un'azienda
about us

Lineabeta è un'azienda a carattere familiare, costituita nell'ottobre del 1980, specializzata nella produzione di accessori e complementi per l'arredamento del bagno.

Fino agli anni '90 ha collaborato e prodotto per i grandi marchi internazionali presenti nella distribuzione mondiale per poi presentarsi sul mercato con il proprio Brand e con collezioni che hanno cambiato radicalmente il design del bagno in Italia e all'estero. Fondata da **Carlo Capitanio**, assoluto protagonista nel mercato di riferimento, Lineabeta ha saputo interpretare con idee originali e innovative la trasformazione della stanza da bagno spingendola ad essere uno degli ambienti più curati della casa.

Il pay off "**Everyday design**" mette l'accento sul percorso che l'azienda ha intrapreso già da qualche tempo, senza soluzione di continuità con gli

Lineabeta is a family company established in October of 1980 focused on production of bathroom accessories and complements.

Until the '90s we partnered and produced for major international brands with worldwide distribution channels. Upon that, we created our own brand and collections that have radically changed the bathroom design in Italy and abroad.

Founded by Carlo Capitanio, we have been a leading player in the market and interpreted with original and innovative ideas the transformation of the bathroom pushing it to come one of the most well-finished room of the house.

The payoff "everyday design" focuses on the path that the company has undertaken for some time, without connection with the past thirty years of corporate history: an idea of flexible bathroom setting, comfortable and functional, where living every day in a simple and spontaneous way.

ITA

EN

La Société

Geschichte
histoire

Lineabeta est une société de type familial, constituée en octobre 1980, spécialisée dans la production d'accessoires et compléments d'ameublement pour la salle de bain.

Jusque dans les années 1990, elle a collaboré et produit pour les grandes marques internationales présentes dans la distribution mondiale, pour ensuite s'introduire sur le marché avec sa propre marque et avec des collections qui ont radicalement changé le design de la salle de bain en Italie et à l'étranger. Fondée par Carlo Capitanio, personnage incontournable du marché analogue, Lineabeta a su interpréter avec des idées originales et innovantes la transformation de la salle de bain, la hissant parmi les pièces les plus soignées de la maison.

Le concept de «everyday design» met l'accent sur le parcours que la société a emprunté depuis quelques temps déjà, sans discontinuité avec les trente dernières années d'histoire de la société: une idée d'environnement bain flexible,

Lineabeta Ein Familienunternehmen, gegründet im Oktober 1980, das sich spezialisiert hat auf die Produktion von Zubehör und Badezimmerdekor.

Bis in die 90er Jahre arbeitete es auch für große internationale Marken im Vertrieb und der Produktion und ging dann mit einer eigenen Marke und Kollektion an den Markt, die das Bad-Design in Italien und im Ausland radikal verändert haben. gegründet von Carlo Capitanio, führende Player auf dem Markt, hat Lineabeta mit originellen und innovativen Ideen die Wandlung des Badezimmers in ihrer Arbeit interpretiert und drängt heute darauf, dass das Bad eine der schönsten Stellen des Hauses sein sollte.

Der Pay-off für «Alltagsdesign» legt den Schwerpunkt auf den Weg, den das Unternehmen seit einiger Zeit beschreitet und nahtlos in den letzten dreißig Jahren Firmengeschichte fortgeführt hat: Die Idee von flexiblen Bädern, komfortabel und funktional, wo man Alltag einfach leben und spontan sein kann.

FR

DE



ultimi trenta anni di storia aziendale: un'idea di ambiente bagno flessibile, comodo e funzionale, dove vivere la quotidianità in modo semplice e spontaneo.

Una quotidianità che perdura da trent'anni. Trent'anni spesi a diventare tra i primi tre marchi in Italia e tra i primi cinque al mondo nella produzione di accessori e complementi d'arredo per l'ambiente bagno.

Trent'anni di tempo, energia, esperienza, innovazione, costanza, creatività, visione, legame col territorio e acuto spirito imprenditoriale.

Lineabeta reinterpreta la "glocalizzazione" grazie anche al forte legame con il territorio di origine. I differenti materiali (vetro, ottone, acciaio, alluminio, ceramica, bambù, mattstone) provengono da un contesto internazionale, vengono lavorati in Italia o all'estero a seconda della competitività e specializzazione delle manifatture, ma gli elementi strategici come l'immagine e la creatività del design sono rigorosamente

It's an everyday mood that has been standing for thirty years. Thirty years spent to become one of the top three brands in Italy and among the top five in the world in the production of bathroom accessories and complements.

Thirty years of time, energy, experience, innovation, perseverance, creativity; vision, connection with our territory and keen entrepreneurial spirit

Lineabeta reinterprets the "glocalization" thanks to the strong link our territory of origin. The different materials (glass, brass, steel, aluminum, ceramic, bamboo, mattstone) come from an international context, and are processed in Italy or abroad depending on the competitiveness and specialization of factories. But the strategic elements as brand and design creativity are strictly "Made in Italy", such as the names of the lines inspired by Venetian idioms (curve, Roersa, Ciacole, Tirela, Strika, Baketo, etc.).

Names that result in beautiful and durable accessories at fair market price. A policy rewarded year after year which has enabled the company to conquer new

ITA

EN



confortable et fonctionnel, ou vivre le quotidien de façon simple et spontanée. Une réalité quotidienne qui perdure depuis trente ans. Trente ans passés à devenir parmi les trois premières marques en Italie et parmi les cinq premières marques mondiales dans la production d'accessoires et compléments d'ameublement pour la salle de bain. Trente années de temps, énergie, expérience, innovation, constance, créativité, vision, lien avec le territoire et esprit entrepreneurial aiguisé. Lineabeta réinterprète la «Glocalisation» aussi grâce au fort lien avec son territoire d'origine. Les différents matériaux (verre, laiton, acier, aluminium, céramique, bambou, pierre composite) proviennent d'un contexte international, sont travaillés en Italie ou à l'étranger en fonction de la compétitivité et spécialisation des manufactures, mais les éléments stratégiques tels que l'image et la créativité du design sont rigoureusement «Made in Italy», comme le nom des lignes inspirées des langues vénitienes (Curvâ, Roersa, Ciacole,

Eine tägliche Routine, die seit 30 Jahren andauert. Dreißig Jahre hat es gedauert, um unter die Ersten zu kommen mit Drei Marken in Italien und unter den Top Fünf in der Welt bei der Herstellung von Zubehör und Wohnaccessoire für das Badezimmer.

Dreißig Jahre Zeit, Energie, Erfahrung, Innovation, Ausdauer, Kreativität, Vision, Verbindung mit der Basis und scharfem Unternehmergeist

Lineabeta reinterpretiert die «Glokalisierung» dank der starken Verbindung mit ihrem Herkunftsgebiet. Die unterschiedlichen Materialien (Glas, Messing, Stahl, Aluminium, Keramik, Bambus, matter Stein) zeugen von einem internationalen Kontext und sind in Italien oder im Ausland verbreitet, in Abhängigkeit von der Wettbewerbsfähigkeit und Spezialisierung von Fabriken, aber die strategischen Elemente wie das Bild und Design und die Kreativität sind streng «Made in Italy». Die Namen der Linien sind von venezianischen Idiomen inspiriert (Curva, Roersa, Ciacole,

FR

DE

"Made in Italy", come i nomi delle linee ispirati agli idiomi veneti (Curvà, Roersa, Ciacole, Tirela, Strika, Baketo, ecc.). Nomi che si traducono in complementi belli e durevoli al giusto prezzo di mercato.

Una politica premiata anno dopo anno che ha consentito all'azienda di conquistare mercati sempre nuovi. Il prodotto Lineabeta si posiziona su una fascia medio - alta del mercato, ed i canali di vendita preferenziali sono quelli delle boutiques specializzate nell'arredo bagno, i punti vendita dell'Idrotermosanitario, il retail mobili e il contract.

Parte dei nostri prodotti sono certificati CE, TUV e Made in Italy.

Su richiesta del Cliente, per tipologia di prodotto o per gli standard previsti dal Paese di destinazione, ci rendiamo disponibili per ricerche e certificazioni ad-hoc, avvalendoci del supporto tecnico-professionale di Enti di Certificazione & Qualità Prodotto, nostri Partner da anni.

Dal 2006 siano certificati ISO 9001:2000 per i processi di progettazione, sviluppo, produzione e commercializzazione di complementi d'arredo (CERT-17533-2006-AQ-VEN-SINCERT).

Oggi l'azienda si avvale di una forte presenza distributiva sul proprio territorio nazionale grazie ai 1500 Showroom in Italia che ne esaltano il Brand e l'intera collezione.



markets.

The Lineabeta product is positioned in a middle - high market range, and preferential sales channels are those specialized in bathroom boutiques, plumbing sector sales points, retail and contract furniture.

Part of our products are CE, TUV and Made in Italy: On request of the customer, upon product category or standards required by the destination country; we are willing and able to research and provide certifications, taking advantage of technical and professional support Certification & Product Quality Authorities that have been our partners for years. Since 2006 are ISO 9001:2000 certified for the design, development, manufacture and marketing of furnishings (CERT-17533-2006-AQ-VEN-SINCERT).

Today the company has a strong distribution presence on their territory thanks to the 1500 Showroom in Italy that highlight our brand and collections.

ITA

EN

Tirela, Strika, Baketo, etc.). Des noms qui se traduisent en compléments beaux et durables au juste prix du marché. Une politique récompensée année après année, qui a permis à l'entreprise de conquérir de nouveaux marchés.

Le produit Lineabeta se positionne sur un segment moyen - haut du marché, et les canaux de vente préférentiels sont ceux des boutiques spécialisées dans l'ameublement de salle de bain, les points de vente de hydro-thermo-sanitaires, les détaillants de meubles et le contract. Une partie de nos produits sont certifiés CE, TUV et Made in Italy: Sur demande du client, pour le type de produit ou pour les normes prévues par le pays de destination, nous nous rendons disponibles pour des recherches et certifications ad-hoc, bénéficiant de l'appui technique et professionnel d'organismes de certification et qualité produit, nos partenaires depuis des années.

Depuis 2006, nous sommes certifiés ISO 9001:2000 pour les processus de conception, développement, production et commercialisation de compléments d'ameublement (CERT-17533-2006-AQ-VEN-SINCERT).

Aujourd'hui, la société bénéficie d'une forte présence de distribution sur son propre territoire national, grâce aux 1500 Showrooms en Italie qui en exaltent la marque et la collection complète. En ce qui concerne le marché étranger, important débouché depuis 1987, Lineabeta exporte 40 % de son chiffre d'affaires dans 60 pays du monde.



Tirela, Strika, Baketo, etc.). Namen, die schönes und haltbares Zubehör zu fairen Marktpreis bieten. Eine Politik, Jahr für Jahr belohnt, die es dem Unternehmen ermöglicht hat, neue Märkte zu erobern. Das Produkt Lineabeta positioniert sich in einem mittleren bis hohen Marktsegment und bevorzugte Vertriebskanäle sind Bad-Boutiquen, Vertrieb über Verkaufspunkte im Bereich Sanitär, Absatzpunkte für den Einzelhandel und Objektmöbel. Ein Teil unserer Produkte sind CE, TÜV und Made in Italy zertifiziert.

Auf Wunsch des Kunden oder je nach Produkttyp, der im Zielland erforderlich ist, sind wir für Forschung und Zertifizierung im Ad-hoc-Verfahren bereit, unter Ausnutzung der technischen und professionellen Support- und Zertifizierungsstellen & für Produkt-Qualität, die seit Jahren unsere Partner sind.

Seit 2006 sind wir nach ISO 9001:2000 zertifiziert für die Konzeption, Entwicklung, Herstellung und Vermarktung von Möbeln (CERT-17533-

FR

DE

Per quanto riguarda il mercato estero, sbocco importante fin dal 1987, Lineabeta esporta il 40% del proprio fatturato in 60 Paesi nel mondo.

In particolare è riuscita a consolidare la propria presenza in Germania, Francia, Europa del Nord, USA, Nuova Zelanda, Spagna ed Emirati Arabi.

Sono ben esplicitati nella "Mission" i concetti e valori fondanti la filosofia aziendale.

L'obiettivo è quello di creare un prodotto di design nato dalla creatività italiana; deve essere accessibile, di tendenza e con un equilibrato rapporto qualità/prezzo.

Nel 2016 Lineabeta ha effettuato una profonda riorganizzazione per rispondere in modo più efficace ai cambiamenti del mercato. La nuova struttura per Divisioni o Business Unit riflette la volontà di favorire una presenza "multicanale" in linea con quanto esplicitato nella nuova "Vision": essere protagonisti là dove il bagno è protagonista.

As for the overseas market, major outlet since 1987, Lineabeta exports 40% of its sales in 60 countries worldwide.

In particular we have managed to consolidate our presence in Germany, France, Northern Europe, the USA, New Zealand, Spain and the UAE.

Our concepts and core values are well explained in the "Mission".

Our goal is to create a design product born of Italian creativity; It must be accessible, trendy and with a balanced quality/price ratio.

In 2016 Lineabeta carried out a major reorganization to respond more effectively to market changes. The new structure that is based on divisions -or business units- reflects a desire to promote a multi-channel presence in line with what is set out in our new "Vision": to be protagonists where bathroom is protagonist.

ITA

EN

En particulier, elle a réussi à consolider sa présence en Allemagne, France, Europe du Nord, USA, Nouvelle Zélande, Espagne et Émirats Arabes. Dans la «Mission» sont expliqués les concepts et valeurs fondamentales de la philosophie de l'entreprise. L'objectif est celui de créer un produit design né de la créativité italienne ; il doit être accessible, tendance, et avoir un rapport qualité-prix équilibré.

En 2016, Lineabeta a opéré une profonde réorganisation afin de répondre plus efficacement aux changements du marché. La nouvelle structure par Division ou Unité commerciale reflète la volonté de favoriser une présence «multicanaux» en accord avec le contenu de la nouvelle Vision: être des acteurs là où la salle de bain est un protagoniste..

2006-AQ-VEN-SINCERT).

Heute verfügt das Unternehmen über eine starke Vertriebspräsenz, dank 1500 Showrooms in Italien die zur Verbesserung der Marke und der gesamten Kollektion beitragen. Wir exportieren seit 1987, und Lineabeta erzielt 40% seines Umsatzes in 60 Ländern weltweit. Insbesondere haben wir es geschafft, die Präsenz in Deutschland, Frankreich, Nordeuropa, den USA, Neuseeland, Spanien und den Vereinigten Arabischen Emiraten zu konsolidieren.

In der „Mission“ sind die Konzepte und Grundwerte der Firmenphilosophie erklärt.

Das Ziel ist, einProdukt-Design zu schaffen, geboren aus Italienischer Kreativität; zugänglich für den Trend und mit einem ausgewogenem Qualität-Preis-Leistungs-Verhältnis.

Im Jahr 2016 hat Lineabeta mit einer großen Reorganisation effektiv auf Marktveränderungen reagiert. Die neue Struktur basiert auf Abteilungen und Geschäftsbereichen mit dem Wunsch, eine „Multi-Channel“-Präsenz im Einklang mit dem zu fördern, was in der neuen „Vision“ festgelegt wird: Protagonisten sein, wo das Bad der Protagonist ist.

FR

DE

Dna

Dna
e valori
& values

Lineabeta da oltre trent'anni affronta ogni giorno con rinnovato slancio le esigenze reali di chi desidera progettare e arredare l'ambiente bagno, nonché i bisogni di design, comfort, funzionalità tipiche delle persone che abitano in quegli stessi edifici. Per dare la giusta visibilità alle tematiche che ci stanno a cuore, come l'attitudine all'innovazione, l'approccio positivo alle sfide e il desiderio di contribuire a migliorare la qualità di vita delle persone, Lineabeta ha adottato un brand manifesto e un pay-off, "everyday design", che sono vere e proprie dichiarazioni di intenti.

*"Everyday design",
parla di un'azienda
in evoluzione attenta a
cogliere i trend e a proporre
nuovi stili d'arredo per
l'ambiente bagno.*

ITA

Lineabeta for over thirty years faces every day with renewed enthusiasm the needs of those who want to design and decorate their bathroom. We want to cover as well the needs of design, comfort, functionality typical of people who live in those buildings.

To give the right visibility on the issues that matters to us -such as an attitude to innovation, a positive approach to challenges and the desire to help improving people's quality of lives- Lineabeta adopted a brand manifesto and the pay -off, "everyday design", which are real statements of intent.

*"Everyday Design,"
is about a company in
evolution that is careful
to grasp trends and propose
new styles of furniture
for the bathroom.*

EN

Adn

Dna
et valeurs
und werte

Depuis plus de 30 ans, Lineabeta affronte chaque jour avec un élan nouveau les exigences réelles de ceux qui souhaitent concevoir et aménager sa salle de bain, ainsi que les besoins en design, confort, fonctionnalité typiques des personnes qui habitent dans ces mêmes bâtiments. Pour donner leur juste visibilité aux thématiques qui nous tiennent à cœur, telles que l'attitude innovante, l'approche positive des défis et le désir de contribuer à améliorer la qualité de vie des personnes, Lineabeta à adopté une marque manifeste et un concept, « everyday design » qui sont de vrais déclarations d'intentions.

«Everyday design» parle d'une société en évolution attentive à capturer les tendances et à proposer de nouveaux styles de meubles pour l'aménagement de salle de bain.

FR

Lineabeta stellt sich seit über dreißig Jahren jeden Tag mit neuer Begeisterung auf die tatsächlichen Bedürfnisse derer ein, die ihr Bad gestalten und dekorieren wollen. Neben den Anforderungen an Design und Komfort, suchen wir nach Funktionalität für Menschen, die in den gleichen Gebäuden leben. Um die richtige Sicht auf die Fragen zu geben, die uns wichtig sind, wie die Einstellung zur Innovation, eine positive Herangehensweise an die Herausforderungen und der Wunsch zu helfen, die Qualität des Lebens der Menschen zu verbessern, hat Lineabeta ein Manifest entworfen, ein Plakat und ein Pay-off für Alltagsdesign mit wahren Absichtserklärungen.

«Alltagsdesignspricht» von einer Firma, die eine Evolution durchmacht, Trends erfasst und neue Stile von Möbeln für das Bad vorstellt.

DE

Valori / Values / Valeurs / Werte

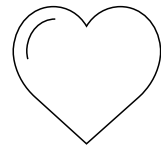

Passione

Alla base del nostro impegno quotidiano ci sono ottimismo, passione e coerenza: elementi importanti per fare un buon lavoro, fondamentali per renderlo gratificante.

Passion

À la base de notre engagement quotidien se trouvent l'optimisme, la passion et la cohérence : des éléments importants pour faire du bon travail, fondamentaux pour le rendre gratifiant.

Passion

The ground of our daily work. We are optimistic, passionate and consistent: these are important elements to do a good job and fundamental to make it rewarding.

Leidenschaft

Die Basis unserer täglichen Arbeit, die wir optimistisch angehen, sind Leidenschaft und Konsequenz: wichtige Elemente, um eine gute und lohnende Arbeit zu machen.

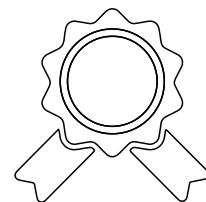

Coraggio

Non c'è spazio per la paura, se si vuole tenere la posizione di testa. Siamo convinti di riuscire a trasformare la difficoltà in vantaggio.

Courage

Il n'y a pas de place pour la peur, lorsqu'on souhaite tenir la position de tête. Nous sommes convaincus de pouvoir transformer la difficulté en avantage.

Courage

There is no room for fear, if you want to keep the lead. We are confident of being able to transform the difficulties ahead.

Mut

Es gibt keinen Raum für Angst, wenn Sie die Führung behalten möchten. Wir sind zuversichtlich, die Schwierigkeiten im Voraus transformieren zu können.

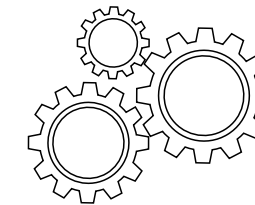

Fare Squadra

Le persone fanno la differenza: condividiamo gli stessi valori, gli stessi obiettivi e costruiamo un dialogo con i nostri Clienti per trovare sempre le soluzioni più adatte.

Faire équipe

Les personnes font la différence: nous partageons les mêmes valeurs, les mêmes objectifs, et construisons un dialogue avec nos clients pour trouver toujours la solution la plus adaptée.

Teamworking

People make the difference: we share the same values and goals, building a dialogue with our customers to find always the best solutions.

Teaming

Menschen machen den Unterschied: Wir teilen die gleichen Werte, die gleichen Ziele und einen Dialog mit unseren Kunden, um immer die besten Lösungen zu finden.

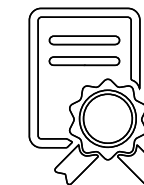

Qualità della vita

Lavoriamo per migliorare la qualità della vita nel rispetto delle persone, dell'ambiente e del futuro della società.

Qualité de vie

Nous travaillons afin d'améliorer la qualité de vie dans le respect des personnes, de l'environnement et du futur de la société.

Quality of life

We work to improve the quality of life with respect for people, environment and the future of society.

Lebensqualität

Wir arbeiten, um die Lebensqualität für die Menschen zu verbessern, für die Umwelt und die Zukunft der Gesellschaft.



Il cambiamento

Crediamo che mantenere un atteggiamento di apertura mentale, lasciare spazio alla creatività e cercare di essere lungimiranti sia vitale; lavoriamo concretamente al miglioramento continuo.

Le changement

Nous pensons que maintenir une attitude d'ouverture d'esprit, laisser de l'espace à la créativité, et chercher à être visionnaire est vital: nous travaillons concrètement une amélioration continue.

Change

We believe that keeping an open mind leaving room for creativity and trying to be forward-thinking is vital; we work hard on continuous improvement.

Die Änderung

Wir glauben, dass ein offener Geist Raum für Kreativität schafft und wir versuchen, zukunftsorientiert zu arbeiten; das ist von entscheidender Bedeutung; wir arbeiten hart an der kontinuierlichen Verbesserung.

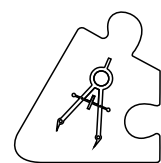

Integrità

Vogliamo fare sempre un buon lavoro. Con onestà, trasparenza e competenza, per garantire risultati affidabili.

Intégrité

Nous voulons toujours faire du bon travail. Avec honnêteté, transparence et compétence, pour garantir des résultats fiables.

Integrity

We always do a good job: with honesty, transparency and competence, to ensure reliable results.

Integrität

Wir wollen immer einen guten Job machen. Mit Ehrlichkeit, Transparenz und Kompetenz, um zuverlässige Ergebnisse zu gewährleisten.



Manifesto / *Manifesto* / *Manifeste* / *Manifeste*



Siamo ottimisti e appassionati

Gratificati da un lavoro che viviamo
come un impegno quotidiano:
prima di tutto verso noi stessi.

We are optimistic and passionate

*Gratified from a job that we live as a
daily commitment:
first of all to ourselves.*

Nous sommes des optimistes et des passionnés

*Gratifiés d'un travail que nous vivons
comme un engagement quotidien:
tout d'abord envers nous-mêmes.*

Wir sind optimistisch und leidenschaftlich.

*Empathisch mit einem Job, den wir als
tägliches Engagement leben: in erster
Linie für uns selbst.*

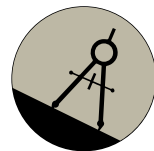

Pensiamo al bagno

come l'ambiente che più di tutti
avvalora e qualifica una casa.

We think of bathrooms

*The environment that most of all
validates and distinguishes a home.*

Nous pensons la salle de bains

*comme la pièce qui, plus que tout autre,
donne de la valeur et du cachet
à une maison.*

Wir denken an das Badezimmer

*wie auch an die Umwelt, die auch ein Teil
ist, das ein Haus qualifiziert.*



Promuoviamo la cultura del cambiamento

attraverso la ricerca e l'innovazione:
per offrire nuove idee di design ai nostri
clienti; per facilitare l'attività dei nostri
partner e fornire soluzioni intelligenti ai
progettisti; per trasmettere tranquillità
e offrire certezze sulla funzionalità dei
nostri prodotti.

We promote the culture of change

*Through research and innovation:
To offer new design ideas to our
customers; To ease the activities of our
partners and provide intelligent solutions
to designers; To instill tranquility and
provide certainty about the functionality
of our products.*

Nous promovons la culture du changement

*à travers la recherche et l'innovation :
pour offrir de nouvelles idées design à
nos clients; pour faciliter l'activité de
nos partenaires et fournir des solutions
intelligentes aux concepteurs; pour offrir
la tranquillité et des certitudes quant à la
fonctionnalité de nos produits.*

Wir fördern die Kultur des Wandels

*Forschung und Innovation
neue Designideen für unsere Kunden zu
bieten; die Aktivitäten unserer Partner
und intelligente Lösungen für Designer
zu erleichtern; Ruhe und Sicherheit über
die Funktionalität unserer Produkte zu
vermitteln.*

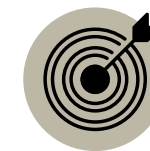

Siamo coraggiosi e fiduciosi

che la nostra storia è la storia di chi
per passione ricerca costantemente il
senso del bello in tutte le cose.

We are brave and confident

*Our history is the story of those
who look for passion
and sense beauty in all things.*

Nous sommes courageux et confiants

*dans le fait que notre histoire est l'histoire de
celui qui, par passion, recherche constamment
la beauté en toute chose.*

Wir sind mutig und zuversichtlich

*dass unsere Geschichte die Geschichte derer
ist, die mit Leidenschaft konsequent den
Sinn für Schönheit in allen Dingen suchen.*



**Facciamo la differenza
con le nostre persone**

in azienda, attraverso la condivisione dei valori e l'acquisizione di nuove competenze; all'interno degli Showroom, attraverso il dialogo e la collaborazione con i clienti; sul mercato, con l'onestà, la trasparenza e la lungimiranza che hanno sempre caratterizzato la nostra storia.

***We make a difference
with our people***

Inside the company through the sharing of values and the acquisition of new skills; inside the showroom, through dialogue and collaboration with customers; on the market, with honesty, transparency and vision that have always characterized our history;

***Nous faisons la différence
avec notre personnel***

en entreprise, à travers le partage des valeurs et l'acquisition de nouvelles compétences; dans les Showroom, à travers le dialogue et la collaboration avec les clients; sur le marché, avec l'honnêteté, la transparence et la clairvoyance qui ont toujours caractérisé notre histoire.

***Wir machen den Unterschied
mit unseren Leuten***

in der Firma, über den Austausch von Werten und dem Erwerb neuer Fähigkeiten; im Innern des Ausstellungsraums, durch den Dialog und die Zusammenarbeit mit den Kunden; auf dem Markt, mit Ehrlichkeit, Transparenz und Vision, was unsere Geschichte immer geprägt hat.



lineabeta®

Mission

Realizziamo soluzioni di design per il bagno capaci di influenzare gli stili di vita delle persone grazie a prodotti nati dalla creatività italiana.

We create design solutions for the bathroom able to shape people's lifestyles with products born from the italian creativity.

Nous mettons au point des solutions de design pour la salle de bain, capables d'influencer le style de vie des personnes, grâce à des produits nés de la créativité italienne.

Wir erschaffen Designlösungen für das Bad, um die Lebensweise der Menschen mit Produkten, geboren aus der Kreativität Italiens, positiv zu beeinflussen.

ITA
EN

FR
DE

Vision

Vogliamo essere protagonisti là dove il bagno è protagonista.

We want to be protagonists where the bathroom is protagonist.

Nous voulons être acteurs, là où la salle de bain est un personnage.

Wir wollen Protagonisten sein, wo das Bad ist der Protagonist ist.

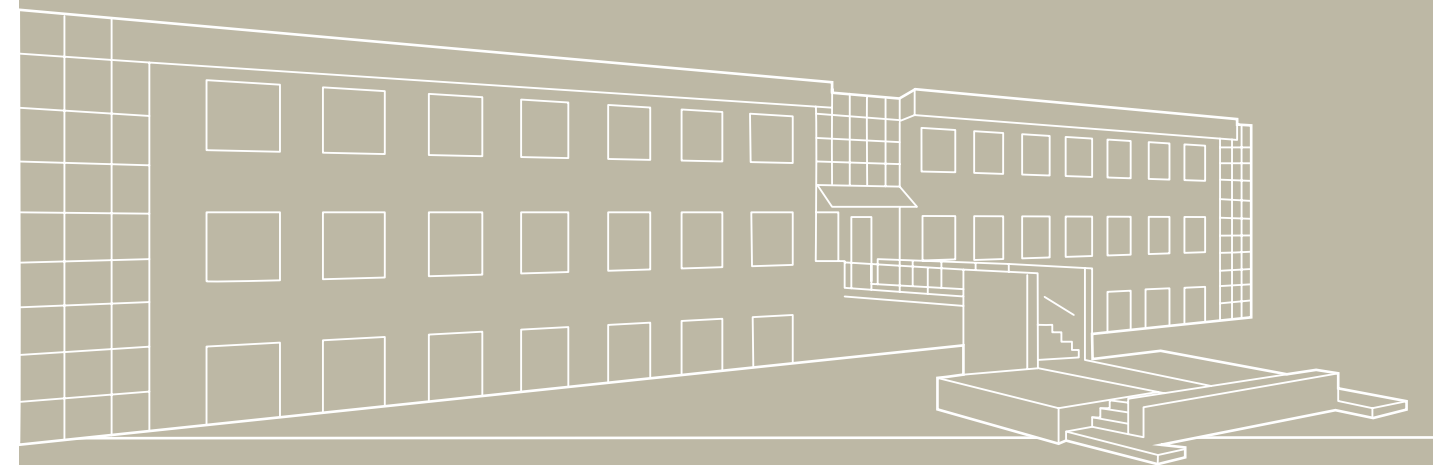

ITA
EN

FR
DE

Index



Collezione Accessori

Accessories Collection
Collection Accessoires
Kollektion Zubehöre

GRELA	Accessori alluminio cromati e verniciati / Chromed and painted aluminium accessories / Accessoires aluminium chromé et verni / Zubehöre aus verchromtem und lackiertem Aluminium	37
SAETA	Accessori alluminio verniciato / Painted aluminium accessories / Accessoires aluminium verni / Zubehöre aus lackiertem Aluminium	43
TACÀ	Accessori ottone cromato / Chromed brass accessories / Accessoires laiton chromé / Zubehöre aus verchromtem Messing	49
PIEGÀ	Accessori alluminio verniciato / Painted aluminium accessories / Accessoires aluminium verni / Zubehöre aus lackiertem Aluminium	55
CURVÀ	Accessori alluminio verniciato / Painted aluminium accessories / Accessoires aluminium verni / Zubehöre aus lackiertem Aluminium	63
ROERSA	Accessori acciaio inox / Stainless steel accessories / Accessoires acier inox / Zubehöre aus Edelstahl	71
ICSELLE	Accessori alluminio verniciato / Painted aluminium accessories / Accessoires aluminium verni / Zubehöre aus lackiertem Aluminium	77
STRIKA	Accessori acciaio inox / Stainless steel accessories / Accessoires acier inox / Zubehöre aus Edelstahl	83
SKUARA	Accessori ottone cromato / Chromed brass accessories / Accessoires laiton chromé / Zubehöre aus verchromtem Messing	89
BAKETO	Accessori ottone cromato / Chromed brass accessories / Accessoires laiton chromé / Zubehöre aus verchromtem Messing	101
DUEMILA	Accessori ottone cromato / Chromed brass accessories / Accessoires laiton chromé / Zubehöre aus verchromtem Messing	113
MUCI	Accessori ottone cromato / Chromed brass accessories / Accessoires laiton chromé / Zubehöre aus verchromtem Messing	123
PICOLA	Accessori ottone cromato / Chromed brass accessories / Accessoires laiton chromé / Zubehöre aus verchromtem Messing	129
NAPIE	Accessori ottone cromato / Chromed brass accessories / Accessoires laiton chromé / Zubehöre aus verchromtem Messing	137
VENESSIA	Accessori ottone cromato / Chromed brass accessories / Accessoires laiton chromé / Zubehöre aus verchromtem Messing	145
KIT TAKE AWAY	Accessori in kit / Accessories kit / Kit d'accessoires / Kit von Zubehöre	153



Accessori Appoggio

Tabletop Accessories
Accessoires à Poser
Zubehöre zum Stand

SAON	Accessori appoggio / Tabletop accessories / Accessoires à poser / Zubehöre zum Stand	167
------	--	-----



Piantane

Stands
Ensembles d'Accessoires
sur Pied
Wc Kombination
und Handtuchständer

GRELA	Piantane in alluminio cromato e verniciate / Chromed and painted aluminium stands / Ensembles d'accessoires sur pied en aluminium chromé et verni / Handtuchständer aus verchromtem und lackiertem Aluminium	181
POSÀ	Piantane verniciate / Painted stands / Ensembles d'accessoires vernis / Lackierte Handtuchständerries	185

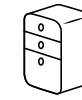

Contentori & Mobili

Cabinets and Furniture
Armoires et Meubles
Schränke

GRELA	Mobili in legno e alluminio cromato e verniciato / Wood and chromed or painted aluminium furniture / Meubles en bois et aluminium chromé et verni / Schränken aus Holz und verchromtem und lackiertem Aluminium	201
CANAVERA	Mobili in bambù / Bamboo furniture / Meubles en bambou / Schränke aus Bamboo	221
CIACOLE	Contentori in alluminio verniciato / Painted aluminium cabinets / Armoires en aluminium verni / Schränke aus lackiertem Aluminium	233
PIKÀ	Contentori in acciaio inox / Stainless steel cabinets / Armoires en acier inox / Schränke aus Edelstahl	239
RUNNER	Mobili con ruote in acciaio inox e verniciati / Stainless steel and painted cabinets on wheels / Meubles sur roulettes en acier inox et vernis / Rollschränke aus Edelstahl und lackiert	245



Specchi & lampade

Mirrors and Lamps
Miroirs et Lampes
Spiegel und Lampen

SPECI	Specchi a muro / Wall mirrors / Miroirs / Wandspiegel	253
MEVEDO	Specchi ingranditori / Magnifying mirrors / Miroirs grossissants / Wand-Vergrößerungsspiegel	265
CIARI	Lampade / Lamps / Lampes / Lampen	273

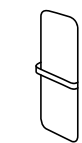

Termoarredi

Design Radiators
Radiateurs
Heizkörper

CALIGO	Termoarredi verniciati / Painted radiators / Radiateurs vernis / Heizkörper lackiert	285
--------	--	-----



Collezione Lavabi

Washbasins
Collections Lavabos
Kollektion Waschbecken

QUARELO	Lavabi ceramica / Ceramic washbasins / Lavabos en céramique / Waschbecken aus Keramik	299
MOMON	Lavabi mattstone / Mattstone washbasins / Lavabos en mattstone / Waschbecken aus Mattstone	303
ACQUAIO	Vasche appoggio / Countertop washbasins / Lavabos à poser / Aufsatzbecken	309
GOTO	Set supporto vasche / Wall bearing washbasins set / Sets support pour lavabos / Halter für Waschbecken	315
CIUCI	Lavamani mattstone / Mattstone washbasins / Lave-mains en mattstone / Waschbecken aus Mattstone	317
POCIA	Lavamani vetro / Glass washbasins / Lave-mains en verre / Waschbecken aus Glas	319
GALATEO	Lavabi ceramica / Ceramic washbasins / Lave-mains en céramique / Waschbecken aus Keramik	321

Index



Doccia

Shower
Douche
Dusche

ISTÀ	Doccia da esterni / Outdoor shower / Douche pour usage externe / Aussendusche	325
SUPIONI	Soffioni doccia / Shower heads / Pommes de douche / Kopfbrause	329
LINEA DOCCIA	Supporti doccia / Shower supports / Supports pour douche / Halter für Dusche	343
FILO	Griglie doccia / Shower grids / Paniers douche / Duschkörbe	351
ATLANTICA	Pedane doccia / Shower mats / Caillebotis / Duschfußbrett	357
KIT TAKE AWAY	Accessori in kit / Accessories kit / Kit d'accessoires / Kit von Zubehör	359



Scopini

Toilet brush holders
Porte-balais
We Bürste

BASTON	Scopini ceramica e silicone / Silicon and ceramic Toilet brush holders / Porte-balais en céramique et silicone / Wc Bürstengarnitur aus Silikon und Keramik	369
SKOATI	Scopini metallo / Metal Toilet brush holders / Porte-balais en métal / Wc Bürstengarnitur aus Metall	373



Complementi

Compléments
Compléments
Ergänzungen

TAPEI	Tappeti cotone / Cotton rugs / Tapis en coton / Teppich aus Baumwolle	381
BANDONI	Cesti alluminio verniciato / Painted aluminium baskets / Corbeilles et paniers à linge en aluminium verni / Körbe aus lackiertem Aluminium	385
BASKET	Cesti acciaio inox / Stainless steel baskets / Corbeilles et paniers à linge en acier inox / Körbe aus Edelstahl	389
SESTI	Cesti metallo brunito / Burnished metal baskets / Paniers à linge en métal bruni / Körbe aus brüniertem Metall	395
SCAGNI	Sgabelli / Stools / Tabourets / Hocker	399



Hotel & Contract

Hotel & Contract
Hôtel
Hotel

OTEL	Accessori hotellerie / Hotel Accessories / Accessoires hotellerie / Hotel Zubehör	405
------	---	-----



Sifoni, Pilette & Rubinetteria

Siphons, Water Drains and Faucets
Siphons, Bondes et Robinetterie
Siphons, Ablaufgarnituren und Armaturen

BUSI & CANE	Sifoni e pilette / Siphons and water drains / Siphons et bondes / Siphons und Ablaufgarnituren	417
LINEA	Prese acqua / Water outlet / Sorties d'eau / Wandanschlussbogen	423
CANOLE	Rubinetteria acciaio inox / Stainless steel faucets / Robinetterie en acier inox / Armatur aus Edelstahl	427
I.NOX	Rubinetteria acciaio inox / Stainless steel faucets / Robinetterie en acier inox / Armatur aus Edelstahl	435
SECIARI	Rubinetteria cucina / Kitchen faucets / Robinetterie pour cuisine / Küchenarmaturen	441

Finiture

Finishing
Finitions
Ausführungen

447

Legenda

Legend
Legende
Légende

Made in Italy



Made in Europe



Novità
New
Nouvelles
Neuheit



Incollo a muro
Wall adhesive
Adhésif mural
Wand Kleber



Fissaggio a muro
Wall mounting with screws
Fixation murale par vis
Wandbefestigung mit Schraube



Reversibile
Reversible
Réversible
Umkehrbar



Articolo con led
Article with leds
Article avec diodes électroluminescentes
Artikel mit LED



Led caldo
Led warm
Led chaud
Warme Led



Led freddo
Led cold
Led froid
Led kalt



Touch
Touch
Toucher
Touch



Ad Acqua
Water
Eau
Wasser



Elettrico
Electric
Électrique
Elektrisch



Acciaio 316
Steel 316
Acier 316
Stahl 316



Acciaio 304
Steel 304
Acier 304
Stahl 304





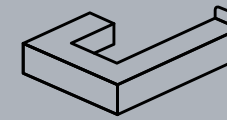



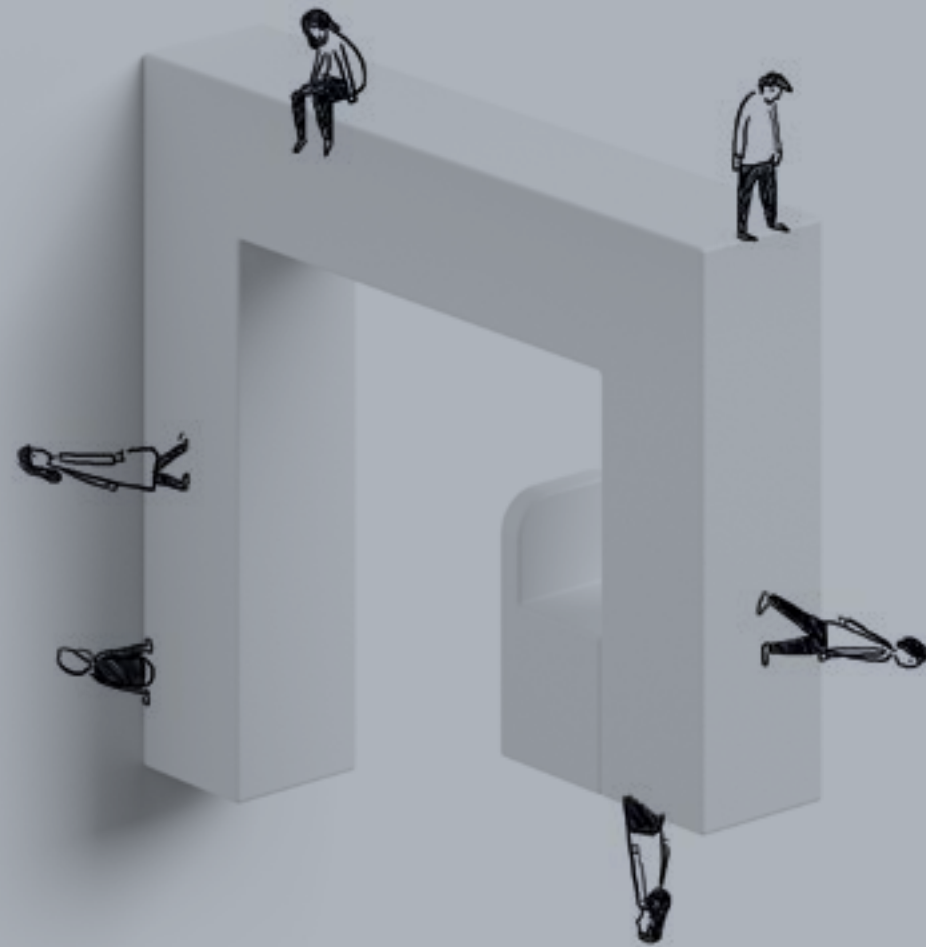



















Collezione Accessori
Accessories Collection
Collection Accessoires
Kollektion Zubehöre



GRELA	Accessori alluminio cromati e verniciati / <i>Chromed and painted aluminium accessories / Accessoires aluminium chromé et verni / Zubehöre aus verchromtem und lackiertem Aluminium</i>		37
SAETA	Accessori alluminio verniciato / <i>Painted aluminium accessories / Accessoires aluminium verni / Zubehöre aus lackiertem Aluminium</i>		43
TACÀ	Accessori ottone cromato / <i>Chromed brass accessories / Accessoires laiton chromé / Zubehöre aus verchromtem Messing</i>		49
PIEGÀ	Accessori alluminio verniciato / <i>Painted aluminium accessories / Accessoires aluminium verni / Zubehöre aus lackiertem Aluminium</i>		55
CURVÀ	Accessori alluminio verniciato / <i>Painted aluminium accessories / Accessoires aluminium verni / Zubehöre aus lackiertem Aluminium</i>		63
ROERSA	Accessori acciaio inox / <i>Stainless steel accessories / Accessoires acier inox / Zubehöre aus Edelstahl</i>		71
ICSELLE	Accessori alluminio verniciato / <i>Painted aluminium accessories / Accessoires aluminium verni / Zubehöre aus lackiertem Aluminium</i>	 	77
STRIKA	Accessori acciaio inox / <i>Stainless steel accessories / Accessoires acier inox / Zubehöre aus Edelstahl</i>		83
SKUARA	Accessori ottone cromato / <i>Chromed brass accessories / Accessoires laiton chromé / Zubehöre aus verchromtem Messing</i>	 	89
BAKETO	Accessori ottone cromato / <i>Chromed brass accessories / Accessoires laiton chromé / Zubehöre aus verchromtem Messing</i>		101
DUEMILA	Accessori ottone cromato / <i>Chromed brass accessories / Accessoires laiton chromé / Zubehöre aus verchromtem Messing</i>	 	113
MUCI	Accessori ottone cromato / <i>Chromed brass accessories / Accessoires laiton chromé / Zubehöre aus verchromtem Messing</i>		123
PICOLA	Accessori ottone cromato / <i>Chromed brass accessories / Accessoires laiton chromé / Zubehöre aus verchromtem Messing</i>		129
NAPIE	Accessori ottone cromato / <i>Chromed brass accessories / Accessoires laiton chromé / Zubehöre aus verchromtem Messing</i>	 	137
VENESSIA	Accessori ottone cromato / <i>Chromed brass accessories / Accessoires laiton chromé / Zubehöre aus verchromtem Messing</i>	 	145
KIT TAKE AWAY	Accessori in kit / <i>Accessories kit / Kit d'accessoires / Kit von Zubehöre</i>	 	153

GRELA

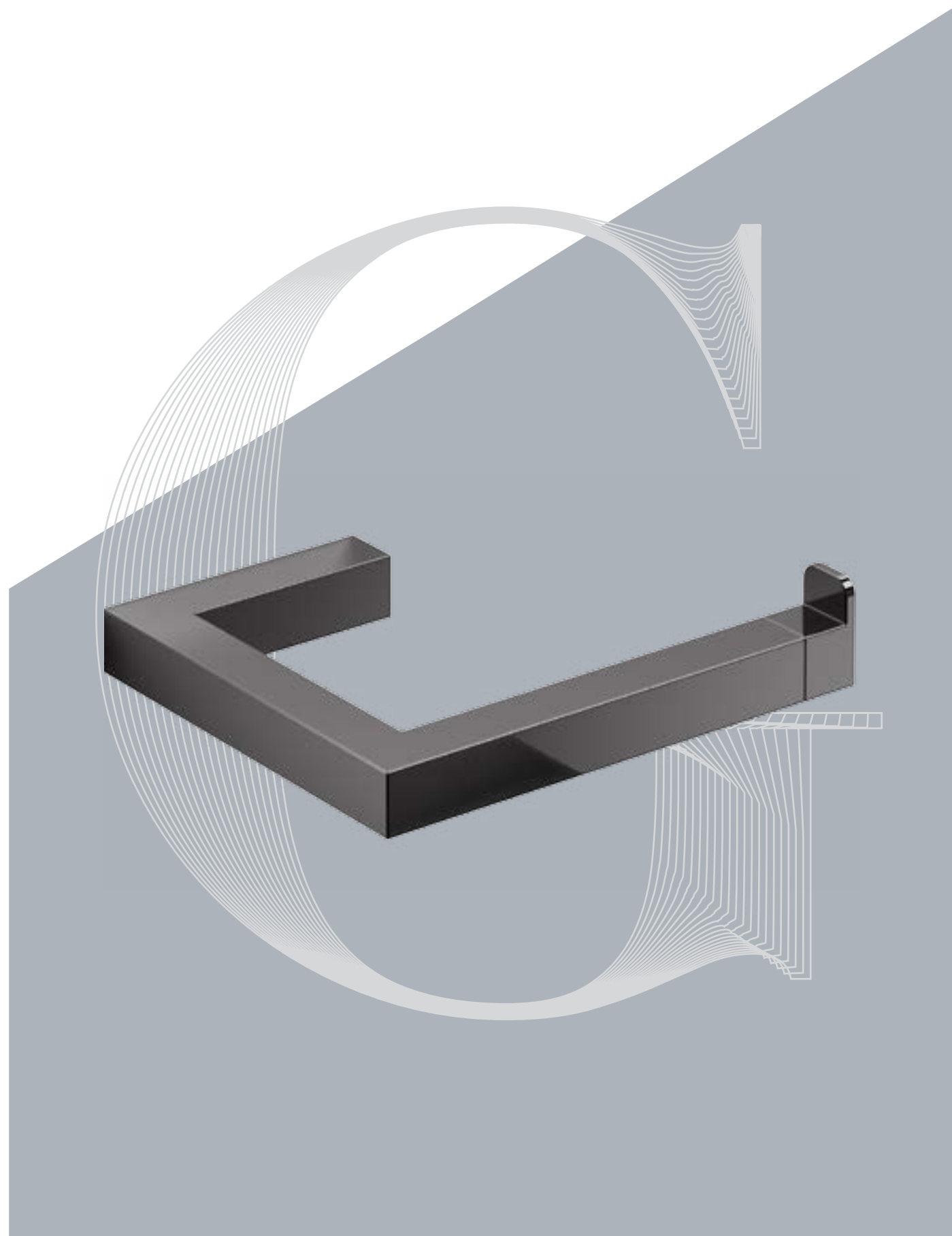

Graticola (Gre-lah).
Collezione di accessori
realizzata in metallo verniciato
o cromato. Ispirata a principi di rigida
precisione, è una serie moderna
e adatta per chi cerca la massima
rigorosità estetica e funzionale.

EN~ *Grill. Collection of accessories made of painted or chromed metal. Inspired by principles of strict precision and modern design, it's suitable to whom seeks maximum aesthetic rigor and functionality.*

FR~ *(Gre-lah) Grille. Collection d'accessoires en métal verni ou chromé. Inspirée des principes de grande précision, c'est une série moderne et adaptée pour qui cherche la plus grande rigueur esthétique et fonctionnelle.*

DE~ *(Gre-lah) Kühlregal. Sammlung von Zubehör aus lackiertem oder verchromtem Metall. Inspiriert von den Prinzipien der strengen Präzision, hat es einen modernen Standard und eignet sich für alle, die maximale ästhetische Strenge und Funktionalität suchen.*

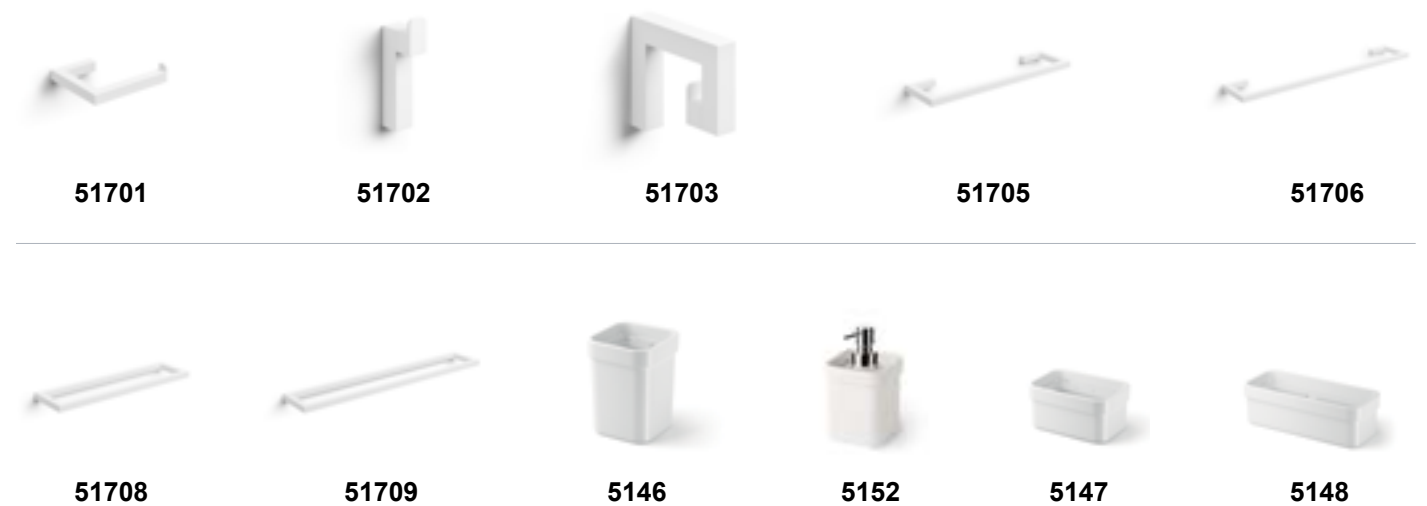



51701 Portarotolo

Toilet paper holder

Porte-rouleau

Toilettenpapierhalter

→ 130 ↑ 15 ↗ 108



51703 Appendino a G

G shaped hook

Patère G

Hacken G

→ 15 ↑ 70 ↗ 85



.09

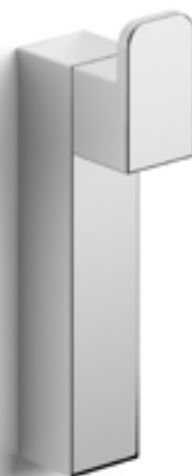

.29



.33

51702 Appendino a L

L shaped hook

Patère L

Hacken L

→ 15 ↑ 80 ↗ 30



51705 Portasalvietta 400 mm

Towel rail 400 mm

Porte-serviettes 400 mm

Handtuchhalter 400 mm

→ 400 ↑ 15 ↗ 108



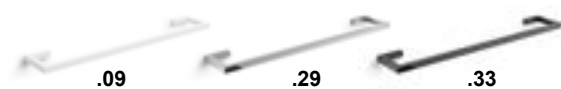

51706 Portasalvietta 600 mm

Towel rail 600 mm
Porte-serviettes 600 mm
Handtuchhalter 600 mm

→ 600 ↑ 15 ↗ 108



51708 Porta accessori 400 mm

Accessories bar 400 mm
Support 400 mm pour accessoires
Halter für Zubehör 400 mm

→ 400 ↑ 15 ↗ 108



51709 Porta accessori 600 mm

Accessories bar 600 mm
Support 600 mm pour accessoires
Halter für zubehöre 600 mm

→ 600 ↑ 15 ↗ 108



5146 Portaspazzolini con coperchio verniciato

Toothbrush holder with painted lid
Porte-brosses à dents avec couvercle vernis
Zahnputzbecher mit lackiertem Deckel

→ 85 ↑ 105 ↗ 85



5147 Portasapone con coperchio verniciato

Soap dish with painted lid
Porte-savon avec couvercle vernis
Seifenschale mit lackiertem Deckel

→ 130 ↑ 60 ↗ 85



5152 Dosasapone con coperchio verniciato

Soap dispenser with painted lid
Distributeur savon liquide avec couvercle vernis

Seifenspender mit lackiertem Deckel

→ 85 ↑ 150 ↗ 90



5148 Scatola portaoggetti con coperchio verniciato

Box with painted lid
Boîte p.objets avec couvercle vernis
Schale mit lackiertem Deckel

→ 205 ↑ 60 ↗ 85



SAETA

Saetta, fulmine. (Sae-tàh)
Collezione di accessori in alluminio dalle forme sottili e dai contorni morbidi, disegnata esclusivamente per l'incollo.

EN~ *Collection of aluminum accessories with subtle and soft shapes designed to be glued on the wall only:*

FR~ *(Sae-tah) Foudre, éclair: Collection d'accessoires en aluminium aux fines formes et contours doux, conçue exclusivement pour coller.*

DE~ *(Sae-tah) Saetta, Blitz. Sammlung von Aluminium-Accessoires mit subtilen und weichen Kanten, ausschließlich zum Kleben entwickelt.*





51801 **Portarotolo**
Toilet paper holder
Porte-rouleau
Toilettenpapierhalter
 → 173 ↑ 50 ↗ 00



51806 **Portasalviette 634 mm**
Towel rail 634 mm
Porte-serviettes 634 mm
Handtuchhalter 634 mm
 → 634 ↑ 50 ↗ 113

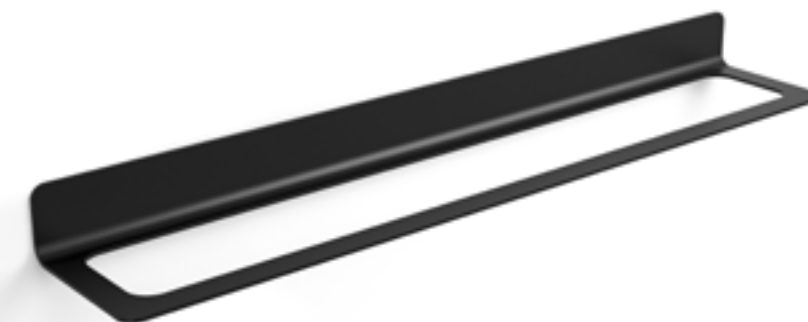

51803 **Appendino**
Hook
Patère
Hacken
 → 110 ↑ 50 ↗ 33



51807 **Mensola 454 mm**
Shelf 454 mm
Tablette 454 mm
Ablage 454 mm
 → 454 ↑ 50 ↗ 113

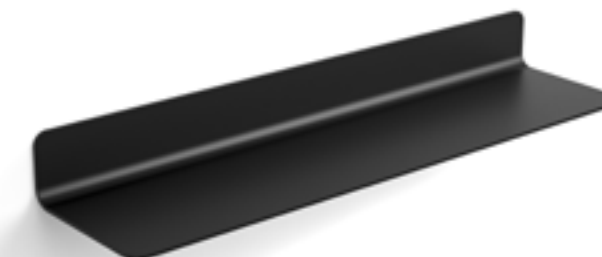

51805 **Portasalviette 454 mm**
Towel rail 454 mm
Porte-serviettes 454 mm
Handtuchhalter 454 mm
 → 454 ↑ 50 ↗ 113



51808 **Mensola 634 mm**
Shelf 634 mm
Tablette 634 mm
Ablage 634 mm
 → 634 ↑ 50 ↗ 113

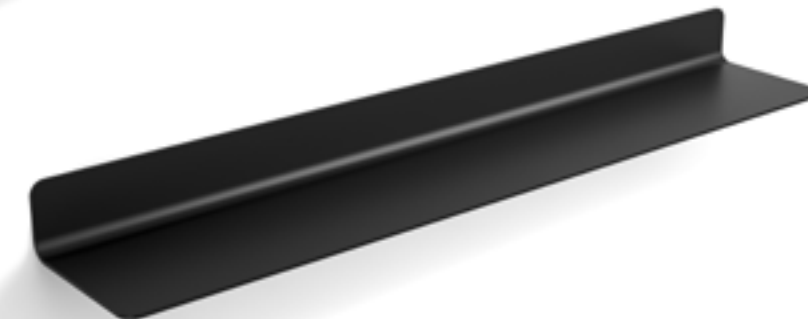



51809 Supporto con mensola 634 mm, foro sx

Towel holder and accessories bar 634 mm, left hole

Etagère avec p.serviettes / support pour accessoires 634 mm, trou à gauche

Halter mit Ablage 634 mm Loch Links

→ 634 ↑ 50 ↗ 113

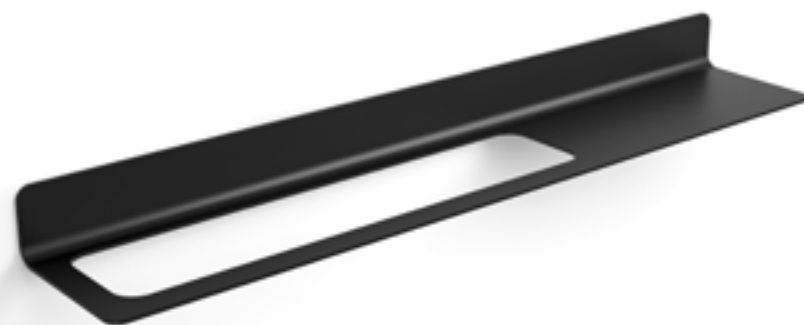

51809DX Supporto con mensola 634 mm, foro dx

Towel holder and accessories bar 634 mm, right hole

Etagère avec p.serviettes / support pour accessoires 634 mm, trou à droite

Halter mit Ablage 634 mm Loch Rechts

→ 634 ↑ 50 ↗ 113

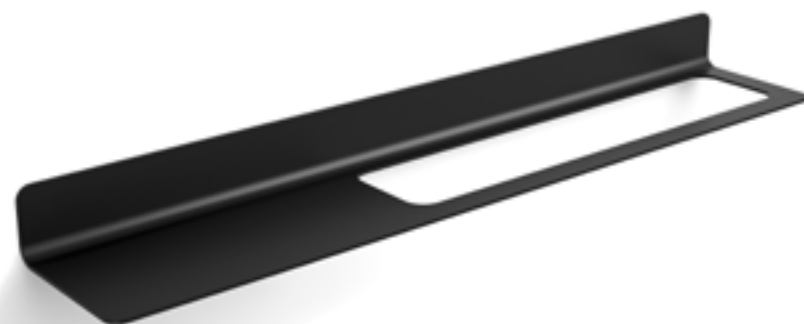

5689 Specchio con luce LED e mensola

Mirror with LED lighting and shelf

Miroir avec étagère et lumière LED

Spiegel mit LED Licht und Ablage

→ 640 ↑ 900 ↗ 150



5146 Portaspazzolini con coperchio verniciato

Toothbrush holder with painted lid

Porte-brosses à dents avec couvercle vernis

Zahnputzbecher mit lackiertem Deckel

→ 85 ↑ 105 ↗ 85



5147 Portasapone con coperchio verniciato

Soap dish with painted lid

Porte-savon avec couvercle vernis

Seifenschale mit lackiertem Deckel

→ 130 ↑ 60 ↗ 85



5152 Dosasapone con coperchio verniciato

Soap dispenser with painted lid

Distributeur savon liquide avec couvercle vernis

Seifenspender mit lackiertem Deckel

→ 85 ↑ 150 ↗ 90



5148 Scatola portaoggetti con coperchio verniciato

Box with painted lid

Boîte p.objets avec couvercle vernis

Schale mit lackiertem Deckel

→ 205 ↑ 60 ↗ 85



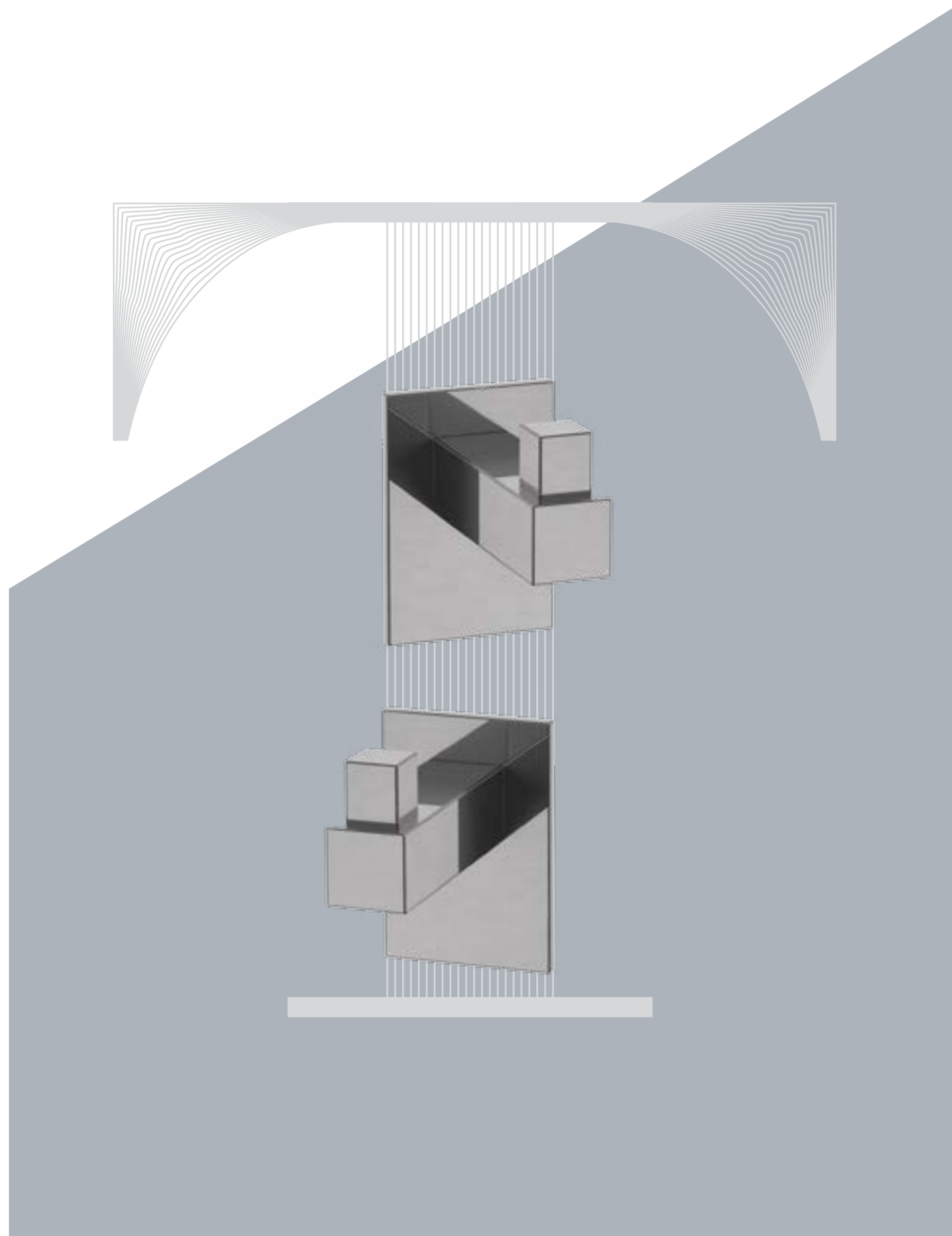

Attaccata. (Tà-càh)
 Collezione di accessori in
 ottone cromato dall'estetica
 moderna e razionale. Disegnata
 esclusivamente per l'incollo.

EN~ *Attached. Chromed brass accessories collection with an aesthetically modern and rational design.*

FR~ *(Tà-càh) Attache. Collection d'accessoires en laiton chromé à l'esthétique moderne et rationnelle.*

DE~ *(Tà-CAH) Angebracht. Aus verchromtem Zubehör Sammlung ästhetisch modern und rational.*



51901.29 Portarotolo

Toilet paper holder

Porte-rouleau

Toilettenpapierhalter

→ 144 ↑ 108 ↗ 66



51905.29 Portasalvietta 440 mm

Towel rail 440 mm

Porte-serviettes 440 mm

Handtuchhalter 440 mm

→ 440 ↑ 60 ↗ 65



51902.29 Appendino singolo

Hook

Patère

Hacken

→ 40 ↑ 63 ↗ 64



51906.29 Portasalvietta 640 mm

Towel rail 640 mm

Porte-serviettes 640 mm

Handtuchhalter 640 mm

→ 640 ↑ 60 ↗ 65



51904.29 Portasalvietta 340 mm

Towel rail 340 mm

Porte-serviettes 340 mm

Handtuchhalter 340 mm

→ 340 ↑ 60 ↗ 65



51910.29 Portasapone

Soap dish with holder

Porte-savon

Halter mit Seifenschale

→ 151 ↑ 69 ↗ 109



51911.29 Portabicchiere

Tumbler holder

Porte-verre

Halter mit Becher

→ 131 ↑ 110 ↗ 89



50054.29 Portascopino quadro

Square toilet brush holder

Porte-balai carré

Toilettenbürstengarnitur quadratisch

→ 80 ↑ 385 ↗ 80



TACÀ kit

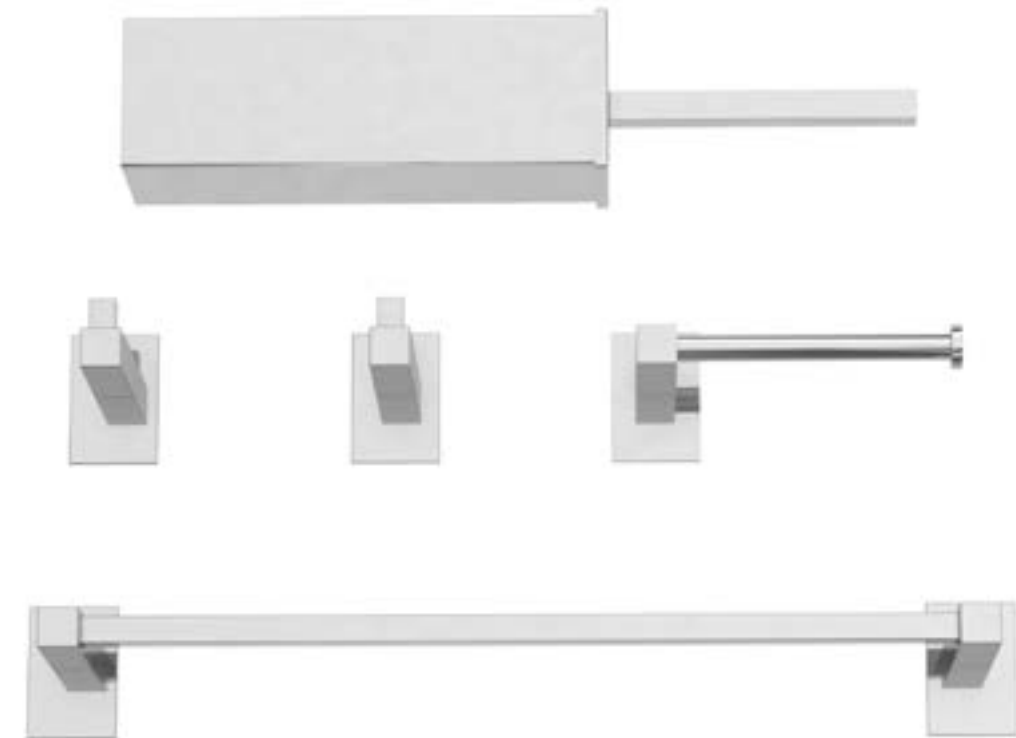

TA-TACÀ INCOLLO

51905.29 / 51902.29 (X2) / 51901.29 / 50054.29

PIEGÀ

Piegà (Pie-ghà) Piegata. Una essenziale collezione di accessori realizzata da un unico foglio di alluminio.

EN~ *(Pie-ghà) Folded. An essential bathroom accessories collection, made from a single sheet of aluminum.*

FR~ *Une collection essentielle d'accessoires, réalisée dans une seule feuille d'aluminium.*

DE~ *Eine wesentliche Sammlung von Zubehör aus einem einzigen Blatt aus Aluminium.*

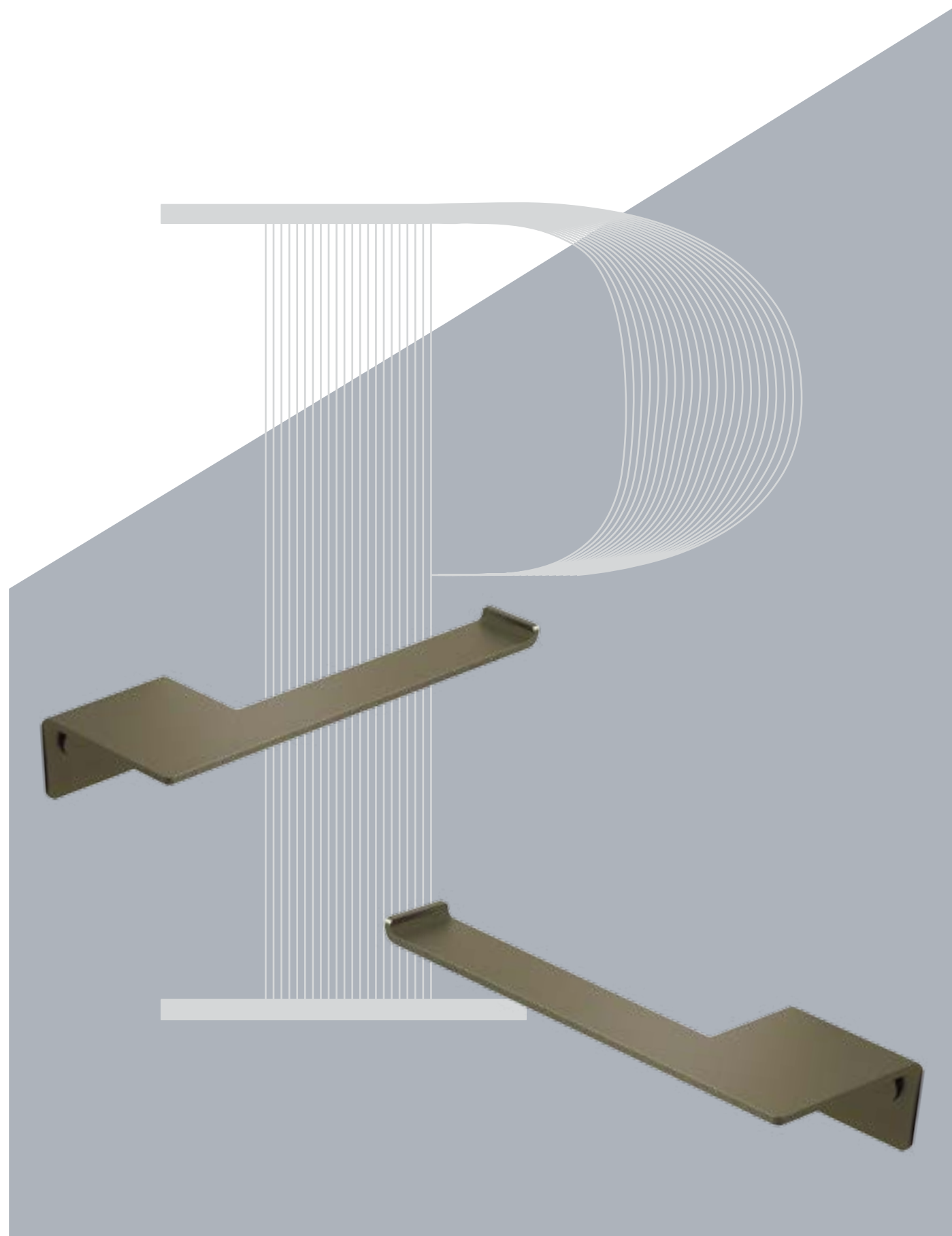

5141



5137



5140



5138-5139



5134



5136



5135



55003



55006



55004



5200

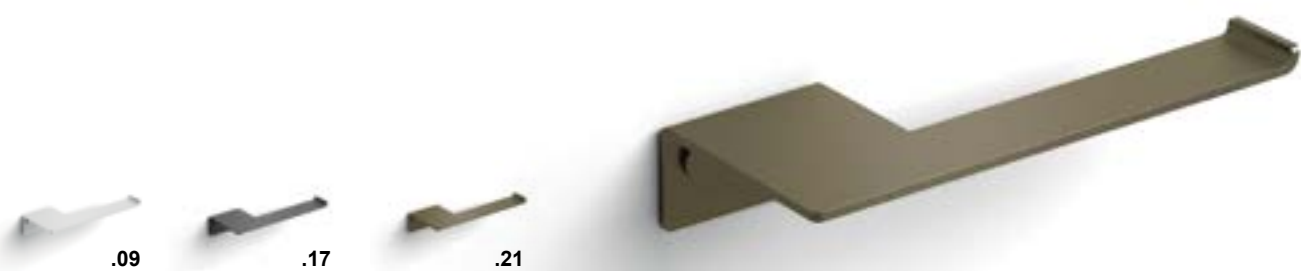

5141 Portarotolo

Toilet paper holder
Porte-rouleau
Toilettenpapierhalter

→ 180 ↑ 35 ↗ 78



5140 Appendino

Hook
Patère
Hacken

→ 150 ↑ 30 ↗ 35



5137 Portarotolo e contenitore

Toilet paper holder with container
Porte-rouleau et récipient
Toilettenpapierhalter und Behälter

→ 270 ↑ 80 ↗ 105



Portasalviette

Towel holder bar
Porte-serviettes
Handtuchhalter

5138 → 400 ↑ 35 ↗ 80

5139 → 600 ↑ 35 ↗ 80





5134 Supporto singolo

Single holder

Support individuel

Halter lose

→ 78 ↑ 35 ↗ 113



5135 Portarotolo con riserva

Toilet paper holder with supply

Porte-rouleau avec réserve

Toilettenpapierhalter mit Reserve

→ 125 ↑ 500 ↗ 120



5136 Portarotolo e portariviste

Toilet paper and magazines holder

Porte-rouleau et magazines

Papierhalter und Magazineträger

→ 395 ↑ 180 ↗ 85



55003 Bicchiere

Tumbler

Verre

Becher

Ø 75 ↑ 105



55006 Dosasapone 200 ml

Soap dispenser 200 ml

Distributeur savon liquide 200 ml

Seifenspender 200 ml

Ø 75 ↑ 185

55004 Portasapone

Soap dish

Porte-savon

Seifenschale

Ø 120 ↑ 30



5200 Griglietta in silicone antiscivolo per Art. 55004 (20 pezzi assortiti in 4 colori)

20 grip grids for soap dish 55004

20 grilles pour porte savon 55004

20 Einlagen für Seifenschale 55004

Ø 50 ↑ 18



CURVÀ



Curvata. Una serie morbida e funky: perchè la bellezza senza espressività è noiosa. Disegnata da Emiliano Aiarci per il Lineabeta LAB 2013, questa serie di barre e accessori in melamina e alluminio verniciato è una ventata di freschezza in un mondo dominato dal cromo. Barre porta accessori o porta asciugamani in bianco regalano una decisa pulizia fin dal primo sguardo.

EN~ *Curved. A soft and funky collection: because beauty without expression is boring. Designed by Emiliano Aiarci for Lineabeta LAB 2013, this painted aluminium bars and melamine accessories collection is a fresh breath in a chromed world. Pure white accessories holder bars or towel holders bestow a decisive clean look at first sight.*

FR~ *Une série douce et funky : car la beauté sans expressivité est ennuyeuse. Conçue par Emiliano Aiarci pour le Lineabeta LAB 2013, cette série de barres et accessoires en mélaminé et aluminium verni est une bouffée d'air frais dans un monde dominé par le chrome. Barres et porte-accessoires ou porte-serviettes en blanc affirment une nette propreté au premier regard.*

DE~ *Eine weiche, flippig Serie: weil Schönheit ohne Ausdruck langweilig ist. Gestaltet von Emiliano Aiarci für Lineabeta LAB 2013 diese Serie mit Stangen und Zubehör in Melamin und Aluminium ist ein Hauch frischer Luft in einer Welt, die von der Chrom dominiert. Dachreling Zubehör Handtuch in weiß geben einen starken sauberen ersten Blick.*



5151



5150



5144-5145



5142-5143



5149-5149DX



5146



5152



5147



5148



5689

5151.09 Portarotolo

Toilet paper holder

Porte-rouleau

Toilettenpapierhalter

→ 115 ↑ 110 ↗ 130



Portasalviette / porta accessori

Towel holder / accessories bar

Porte-serviettes / support

*Handtuchhalter / Halter für
Accessoires*

5144.09 → 460 ↑ 110 ↗ 150

5145.09 → 640 ↑ 110 ↗ 150



5150.09 Appendino

Hook

Patère

Hacken

→ 130 ↑ 100 ↗ 75



Mensola

Shelf

Tablette

Ablage

5142.09 → 460 ↑ 110 ↗ 150

5143.09 → 640 ↑ 110 ↗ 150



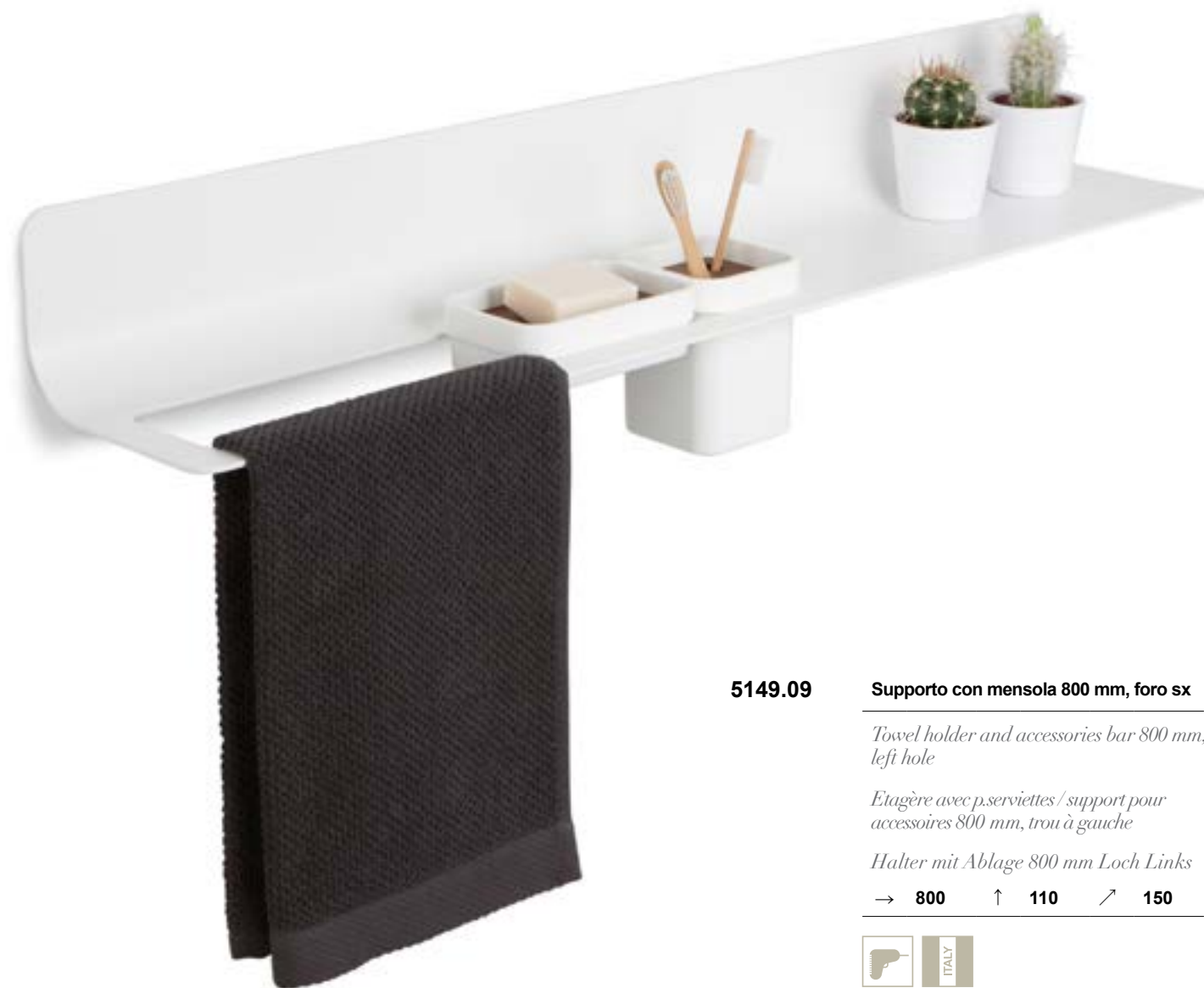

5149.09 Supporto con mensola 800 mm, foro sx
Towel holder and accessories bar 800 mm, left hole
Etagère avec p.serviettes / support pour accessoires 800 mm, trou à gauche
Halter mit Ablage 800 mm Loch Links
 → 800 ↑ 110 ↗ 150



5149DX.09 Supporto con mensola 800 mm, foro dx
Towel holder and accessories bar 800 mm, right hole
Etagère avec p.serviettes / support pour accessoires 800 mm, trou à droite
Halter mit Ablage 800 mm Loch Rechts
 → 800 ↑ 110 ↗ 150



5146 Portaspazzolini con coperchio verniciato
Toothbrush holder with painted lid
Porte-brosses à dents avec couvercle vernis
Zahnputzbecher mit lackiertem Deckel
 → 85 ↑ 105 ↗ 85



5152 Dosasapone con coperchio verniciato
Soap dispenser with painted lid
Distributeur savon liquide avec couvercle vernis
Seifenspender mit lackiertem Deckel
 → 85 ↑ 150 ↗ 90



5147 Portasapone con coperchio verniciato
Soap dish with painted lid
Porte-savon avec couvercle vernis
Seifenschale mit lackiertem Deckel
 → 130 ↑ 60 ↗ 85



5148 Scatola portaoggetti con coperchio verniciato
Box with painted lid
Boîte p.objets avec couvercle vernis
Schale mit lackiertem Deckel
 → 205 ↑ 60 ↗ 85





5689 Specchio con luce LED e mensola

Mirror with LED lighting and shelf

Miroir avec étagère et lumière LED

Spiegel mit LED Licht und Ablage

→ 640 ↑ 900 ↗ 150



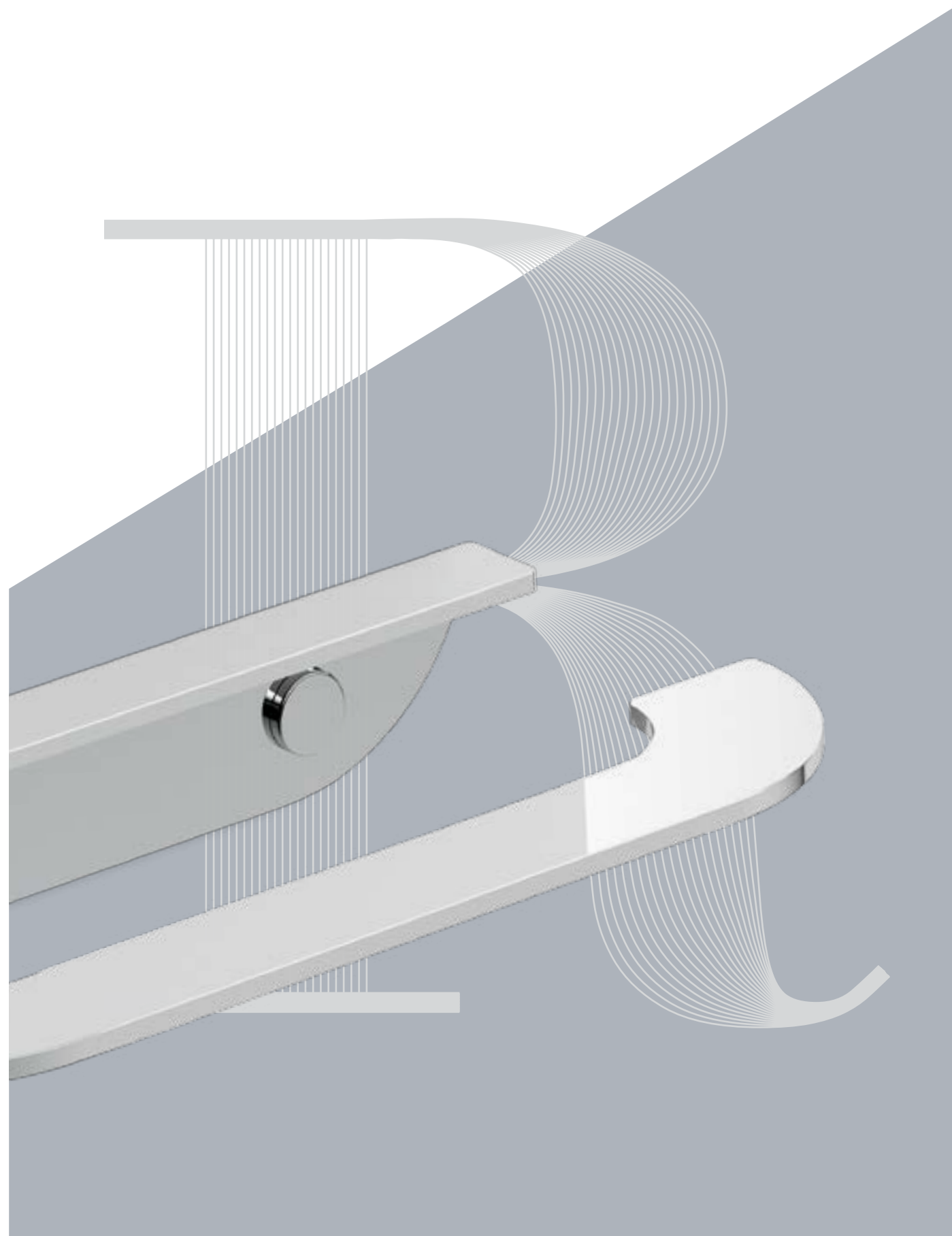

Rovesciata . Dopo il successo della serie **CURVÀ**, proponiamo questa serie che prende ispirazione da quest'ultima.

Realizzata in durevole acciaio inox AISI 316, la serie si integra con gli accessori in melamina della serie **CURVÀ** che scorrono lungo le barre. Queste ultime possono così svolgere una doppia funzione: quella di porta asciugamani o di porta oggetti. La collezione è inoltre comprensiva di copriviti per l'attacco a parete con la stessa finitura del supporto. La serie è disponibile in acciaio lucido e satinato.

EN~ *Reversed . Made by resistant stainless steel AISI 316, this collection matches with CURVÀ melamine accessories. Sliding along bars they perform a double function: towel holder or container. The collection includes also screw caps for wall fixing with the same finishing. This collection is available in polished or satined stainless steel.*

FR~ *Après le succès de la série CURVÀ, nous proposons cette série qui puise inspiration dans cette dernière. Fabriquée en acier inox AISI 316 durable, la série s'intègre aux accessoires en mélaminé de la série CURVÀ qui courent le long des barres. Ces dernières peuvent ainsi endosser une double fonction : celle de porte-serviettes ou de porte-objets. La collection intègre également des cache-vis pour l'attache murale, avec la même finition que le support. La série est disponible en acier poli et brossé.*

DE~ *Nach dem Erfolg der Curve-Serie, bieten wir diese Serie, die ihre Inspiration aus den letzteren nimmt. Hergestellt aus haltbarem Edelstahl AISI 316, integriert die Serie mit der Curve-Serie Zubehör Melamin, die entlang der Stangen laufen. Diese Unternehmen und Agenturen können eine doppelte Rolle spielen: das Handtuch oder Objekten. Die Sammlung ist auch inklusive des Schraubverschlüsse für die Wand mit der gleichen Oberfläche des Substrats montiert werden. Die Serie ist in poliertem und gebürstetem Stahl erhältlich.*

FINITURE / Finishing / Finitions / Oberflächen



chrome.29



satined.32





5161 Portarotolo

Toilet paper holder
Porte-rouleau
Toilettenpapierhalter

→ 180 ↑ 30 ↗ 100



5160 Appendino

Hook
Patère
Hacken

→ 130 ↑ 50 ↗ 30



5164 Portasalvietta / porta accessori 460 mm

Towel holder / accessories bar 460 mm
Porte-serviettes / support (à équiper) 460 mm
Handtuchhalter / Halter für Zubehör 460 mm

→ 460 ↑ 30 ↗ 120



5165 Portasalvietta / porta accessori 640 mm

Towel holder / accessories bar 640 mm
Porte-serviettes / support (à équiper) 640 mm
Handtuchhalter / Halter für Zubehör 640 mm

→ 640 ↑ 30 ↗ 120



5169 Mensola con maniglione 800 mm

Shelf with towel bar 800 mm
Tablette avec porte-serviettes 800 mm
Ablage mit Handtuchhalter 800 mm

→ 800 ↑ 30 ↗ 120





5170 Mensola doccia angolo 200 mm

Shower shelf corner 200 mm
Etagere douche angulaire 200 mm
Duschablage eckig 200 mm

→ 200 ↑ 30 ↗ 200



5171 Mensola doccia 300 mm

Shower shelf 300 mm
Etagere douche 300 mm
Duschablage 300 mm

→ 300 ↑ 30 ↗ 120



5172 Mensola doccia 600 mm

Shower shelf 600 mm
Etagere douche 600 mm
Duschablage 600 mm

→ 600 ↑ 30 ↗ 120

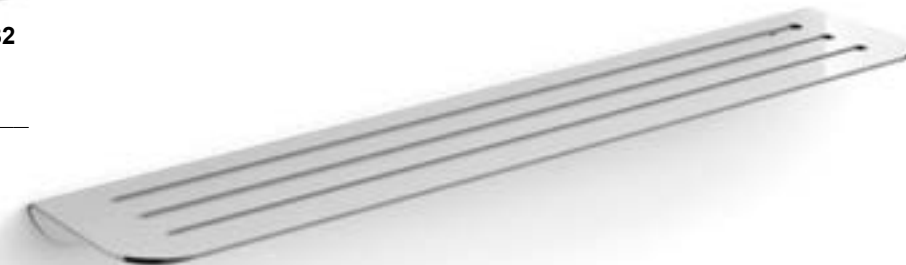

5146 Portaspazzolini con coperchio verniciato

Toothbrush holder with painted lid
Porte-brosses à dents avec couvercle vernis
Zahnputzbecher mit lackiertem Deckel

→ 85 ↑ 105 ↗ 85



5152 Dosasapone con coperchio verniciato

Soap dispenser with painted lid
Distributeur savon liquide avec couvercle vernis

Seifenspender mit lackiertem Deckel

→ 85 ↑ 150 ↗ 90



5147 Portasapone con coperchio verniciato

Soap dish with painted lid
Porte-savon avec couvercle vernis
Seifenschale mit lackiertem Deckel

→ 130 ↑ 60 ↗ 85



5148 Scatola portaoggetti con coperchio verniciato

Box with painted lid
Boîte p.objets avec couvercle vernis
Schale mit lackiertem Deckel

→ 205 ↑ 60 ↗ 85



ICSELLE



XL. La serie **ICSELLE** è la naturale evoluzione della serie **SKUARA**. In massiccio alluminio cromato o verniciato, è una serie dal design puro e importante, dotata di attacchi a muro che garantiscono alta resistenza e la possibilità di incollaggio. Accessori in ceramica da appoggio scorrono lungo tutta la lunghezza della barra e completano una collezione che è già classico.

EN~ *XL. The ICSELLE collection is the natural evolution of SKUARA. Made of massive chromed or painted aluminium Made in Europe with a pure and important design. It's completed by strong and resilient wall fixings with screws or glue. Ceramic accessories slide along the whole bar lenght and complete a collection that's already a classic.*

FR~ *La série ICSELLE est l'évolution naturelle de la série SKUARA. En aluminium massif chromé ou verni, Made in Europe, c'est une série au design épuré et important, dotée d'attaches murales qui garantissent une forte résistance et la possibilité d'un collage. Des accessoires en céramique d'appui coulissent sur toute la longueur de la barre et complètent une collection déjà classique.*

DE~ *Die ICSELLE Serie ist die natürliche Weiterentwicklung der SKUARA Serie. Mit massivem Aluminium überzogen und Made in Europa, ist es eine Reihe aus reinem und wichtigen Design, mit Wandhalterungen ausgestattet, die eine hohen Widerstandsfähigkeit und die Möglichkeit der Verklebung gewährleistet. Keramik-Zubehör erstreckt sich auf der gesamten Länge der Stange und ergänzt eine Klassiker-Kollektion.*

FINITURE / Finishing / Finitions / Oberflächen



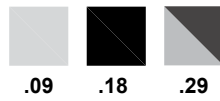

52886 Portarotolo

Toilet paper holder

Porte-rouleau

Toilettenpapierhalter

→ 126 ↑ 40 ↗ 135

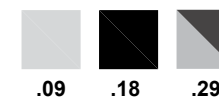

52882 Supporto / Portasalviette 315 mm

Bracket / Towel rail 315 mm

Support / Porte-serviettes 315 mm

Halter / Handtuchhalter 315 mm

→ 316 ↑ 40 ↗ 110



**52880.09 Portarotolo ad incollo per vassoio
Art. 53893.09**

Toilet paper holder to be glued for tray

Porte-rouleau a coller sur plateau

*Toilettenpapierhalter zum Kleben für
Abblage*

→ 126 ↑ 110 ↗ 30



52885 Appendino doppio

Double hook

Patère double

Hacken doppelt

→ 158 ↑ 40 ↗ 50

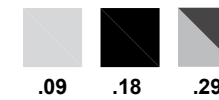

52883 Supporto / Portasalviette 625 mm

Bracket / Towel rail 625 mm

Support / Porte-serviettes 625 mm

Halter / Handtuchhalter 625 mm

→ 624 ↑ 40 ↗ 110



52881 Supporto 160 mm

Bracket 160 mm

Support 160 mm

Halter 160 mm

→ 161 ↑ 40 ↗ 110

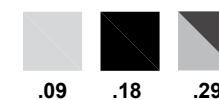

52884 Supporto / Portasalviette 930 mm

Bracket / Towel rail 930 mm

Support / Porte-serviettes 930 mm

Halter / Handtuchhalter 930 mm

→ 931 ↑ 40 ↗ 110



52891.09 Bicchiere

Tumbler

Verre

Becher

→ **76** ↑ **105** ↗ **107**



52894.09 Dosasapone

Soap dispenser

Distributeur savon liquide

Seifenspender

76 ↑ **170** ↗ **107**



52892.09 Portasapone

Soap holder

Porte-savon

Seifenablage

→ **154** ↑ **30** ↗ **107**



52893.09 Vassoio

Tray

Plateau

Tablett

→ **310** ↑ **12** ↗ **107**



STRIKA

S triscia (Stri-cah). Una sottile lama di acciaio inossidabile compone questa collezione di accessori a muro. Inalterabile come il materiale, il suo design senza fronzoli resiste all'usura e al tempo.

EN~ *(Stri-cah) Stripe. A thin stainless steel blade creates this wall accessories collection. Just like the unalterable material, it's design without fripperies stand up to everyday use and passage of time.*

FR~ *Une fine lame d'acier inoxydable compose cette collection d'accessoires muraux. Inaltérable, comme le matériau, son design sans fioritures résiste à l'usure et au temps.*

DE~ *Eine dünne Edelstahlklinge gehört zu dieser Kollektion für Wand-Zubehör dazu. So unveränderbar wie das Material, ist auch sein No-Frills-Design, das der Abnutzung widersteht.*

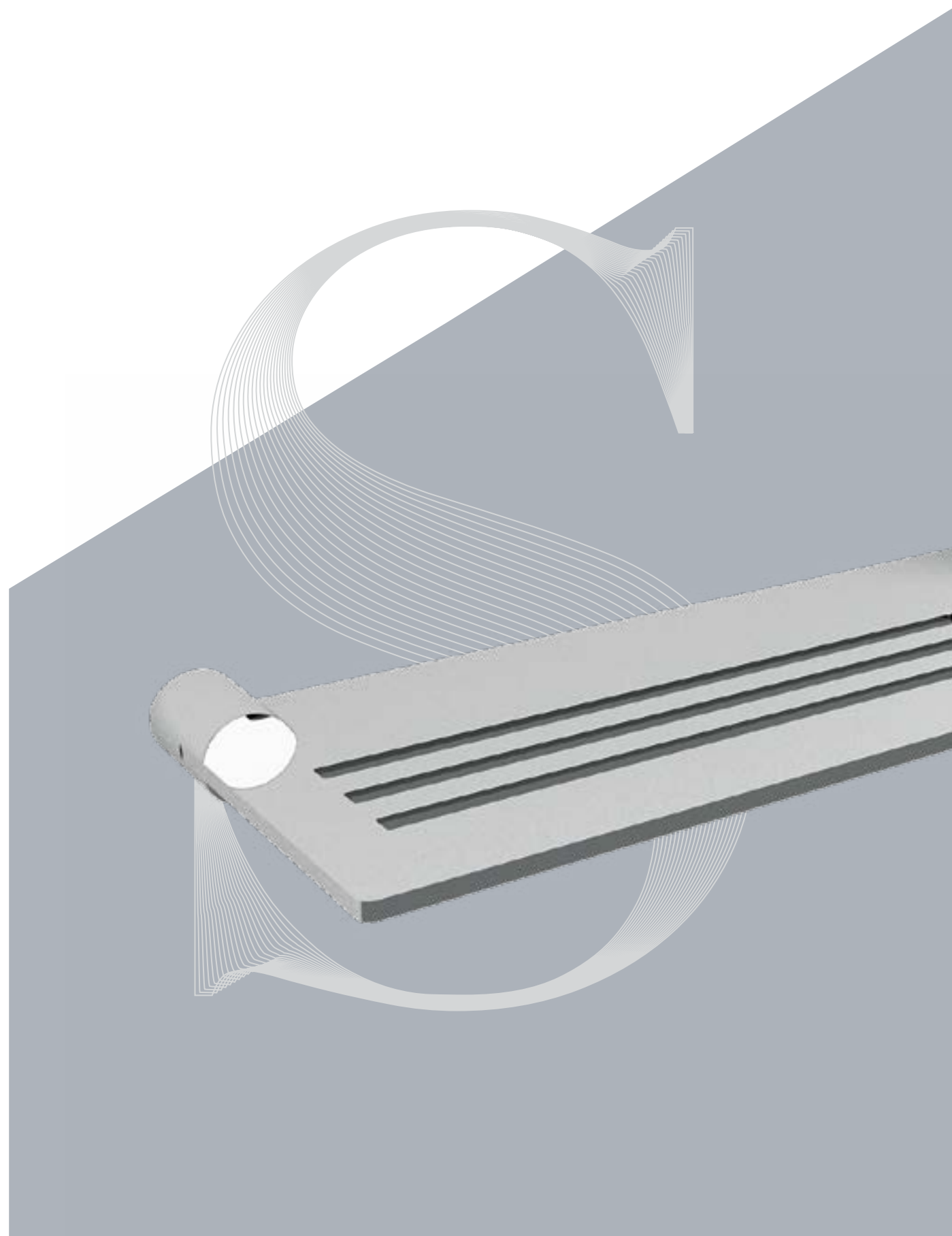

**52954** Portarotolo*Toilet paper holder**Porte-rouleau**Toilettenpapierhalter*

→ 175 ↑ 20 ↗ 63

**52961** Coppia appendini*Two hooks**Paire de patère**Paar Handtuchhaken*

∅ 20 ↗ 40

**52959** Barra portasalviette 550 mm*Towel rail 550 mm**Porte-serviettes 550 mm**Handtuchhalter 550 mm*

→ 550 ↑ 20 ↗ 81

**52957** Barra portasalviette 300 mm*Towel rail 300 mm**Porte-serviettes 300 mm**Handtuchhalter 300 mm*

→ 300 ↑ 20 ↗ 81

**52960** Griglia doccia con supporto per bicchiere 55003, portasapone 55004 o dosasapone 55006*Shower grid with holder for 55003 tumbler; 55004 soap dish or 55006 soap dispenser**Grille douche avec support pour verre 55003 or porte-savon 55004, distributeur savon 55006**Duschablage mit Halterung für Becher 55003, Seifenschale 55004 oder Seifenspender 55006*

→ 330 ↑ 20 ↗ 108

**52958** Barra portasalviette 400 mm*Towel rail 400 mm**Porte-serviettes 400 mm**Handtuchhalter 400 mm*

→ 400 ↑ 20 ↗ 81

**52951** Supporto portasapone, portabicchiere o dosasapone*Tumbler, soap dish support or soap dispenser**Support porte verre, porte-savon ou distributeur savon**Halterung für Seifenschale, Becher oder Seifenspender*

→ 120 ↑ 20 ↗ 122



52964 Appendino per termoarredo e box doccia

Hook for radiator and shower box

Patère douche por radiateur et paroi douche

Hacken für Heizkörper und Glasdusche

→ 25 ↑ 125 ↗ 40



55003 Bicchiere

Tumbler

Verre

Becher

Ø 75 ↑ 105



.09

.80

.81

55006 Dosasapone 200 ml

Soap dispenser 200 ml

Distributeur savon liquide 200 ml

Seifenspender 200 ml

Ø 75 ↑ 185



.09

.80

.81

55004 Portasapone

Soap dish

Porte-savon

Seifenschale

Ø 120 ↑ 30



.09

.80

.81



5200 Griglietta in silicone antiscivolo per Art. 55004 (20 pezzi assortiti in 4 colori)

20 grip grids for soap dish 55004

20 grilles pour porte savon 55004

20 Einlagen für Seifenschale 55004

Ø 50 ↑ 18



52955 Supporto per portascopino 55062

Support for toilet brush holder 55062

Support porte-balais de soutien 55062

Halterung für Wc Bürste 55062

→ 120 ↑ 20 ↗ 120



55062 Portascopino

Toilet brush

Porte-balai

Toilettenbürstengarnitur

Ø 90 ↑ 390



.09

.81

SKUARA



S quadrata (Skù-arra).
na completa linea di
complementi per definire
l'arredamento del bagno con
soluzioni agili e personalizzabili.
Dettagli curati e linee squadrate per
una serie diventata ormai per noi una
seconda firma: in ottone cromato,
acciaio e ceramica.

EN~ *Square. A complete collection of complements for bathroom design with agile and customizable solutions. Fine details and straight lines for a collection that reflects our brand. Made in chromed brass, stainless steel and ceramic.*

FR~ *Une gamme complète d'accessoires pour définir l'ameublement de la salle de bains, avec des solutions adaptables et personnalisables. Détails soignés et lignes carrées pour une série devenue notre seconde signature : en laiton chromé, acier et céramique.*

DE~ *Eine komplette Linie von Zubehör, um die Einrichtung des Badezimmers mit agilen und anpassbaren Lösungen schöner zu definieren. Geschmackvolle Details und quadratische Linien für eine Serie, die für uns eine zweite Unterschrift geworden ist: verchromtes Messing, Stahl und Keramik.*



52806.29 Portarotolo

Toilet paper holder
 Porte-rouleau
 Toilettenpapierhalter

→ 130 ↑ 25 ↗ 135



Supporto

Bracket
 Support
 Halter

52808.29 → 82 ↑ 25 ↗ 100



52810.29 → 100 ↑ 25 ↗ 100



52811.29 → 120 ↑ 25 ↗ 100



52812.29 → 204 ↑ 25 ↗ 100



52807.29 Portarotolo doppio

Double toilet paper holder
 Porte-rouleau double
 Toilettenpapierhalter doppelt

→ 250 ↑ 25 ↗ 135



Supporto / portasalviette

Bracket / towel rail
 Support / porte-serviettes
 Halter / Handtuchhalter

52813.29 → 300 ↑ 25 ↗ 100



52814.29 → 400 ↑ 25 ↗ 100



52815.29 → 500 ↑ 25 ↗ 100



52816.29 → 600 ↑ 25 ↗ 100



52818.29 → 800 ↑ 25 ↗ 100



52853.29 Appendino doppio

Double hook
 Patère double
 Hacken doppelt

→ 155 ↑ 40 ↗ 50



Mensola

Shelf
 Tablette
 Ablage

52834.29 → 400 ↑ 25 ↗ 135

52836.29 → 600 ↑ 25 ↗ 135



52843.29 Griglia 300 mm

Shelf grid 300 mm

Tablette 300 mm

Ablage 300 mm

→ 300 ↑ 25 ↗ 135



52844.29 Griglia 400 mm

Shelf grid 400 mm

Tablette 400 mm

Ablage 400 mm

→ 400 ↑ 25 ↗ 135



52867.29 Griglia con portasalviette 600 mm

Shelf with towel rail 600 mm

Porte-serviettes hotel 600 mm avec barre

Ablage mit Handtuchhalter 600 mm

→ 600 ↑ 115 ↗ 250



52819.29 Portasalviette verticale

Vertical towel holder

Porte-serviettes vertical

Handtuchhalter vertikal

→ 150 ↑ 400 ↗ 170



ADS.03.52819

52801.09 Bicchiere, abbinabile con supporto minimo 80 mm*Tumbler, matching with bracket minimum size 80 mm**Verre, compatible avec support minimum 80 mm**Becher verwendbar mit Halter Minimum 80 mm*

→ 82 ↑ 110 ↗ 100

**52801.29** Bicchiere, abbinabile con supporto minimo 80 mm*Tumbler, matching with bracket minimum size 80 mm**Verre, compatible avec support minimum 80 mm**Becher verwendbar mit Halter Minimum 80 mm*

→ 74 ↑ 100 ↗ 97

52804.09.29 Dosasapone 300 ml, abbinabile con supporto minimo 80 mm*Soap dispenser 300 ml, matching with bracket minimum size 80 mm**Distributeur savon liquide 300 ml, compatible avec support minimum 80 mm**Seifenspender 300 ml, verwendbar mit Halter Minimum 80 mm*

→ 87 ↑ 160 ↗ 100

**52804.29** Dosasapone 350 ml, abbinabile con supporto minimo 80 mm*Soap dispenser 350 ml, matching with bracket minimum size 80 mm**Distributeur savon liquide 350 ml, compatible avec support minimum 80 mm**Seifenspender 350 ml, verwendbar mit Halter Minimum 80 mm*

→ 74 ↑ 185 ↗ 97

**52802.09** Vaschetta portasapone, abbinabile con supporto minimo 120 mm*Soap dish, matching with bracket minimum size 120 mm**Porte-savon, compatible avec support minimum 120 mm**Seifenablage verwendbar mit Halter Minimum 120 mm*

→ 120 ↑ 45 ↗ 100

**52802.29** Vaschetta portasapone, abbinabile con supporto minimo 120 mm*Soap dish, matching with bracket minimum size 120 mm**Porte-savon, compatible avec support minimum 120 mm**Seifenablage verwendbar mit Halter Minimum 120 mm*

→ 113 ↑ 15 ↗ 92

**52803.09** Portaspugna, abbinabile con supporto minimo 200 mm*Sponge dish, matching with bracket minimum size 200 mm**Porte-éponge, compatible avec support minimum 200 mm**Schwammschale verwendbar mit Halter Minimum 200 mm*

→ 204 ↑ 45 ↗ 100

**52803.29** Portaspugna, abbinabile con supporto minimo 200 mm*Sponge dish, matching with bracket minimum size 200 mm**Porte-éponge, compatible avec support minimum 200 mm**Schwammschale verwendbar mit Halter Minimum 200 mm*

→ 197 ↑ 15 ↗ 97



52805.09.29 Portascopino, abbinabile con supporto minimo 100 mm

Toilet brush, matching with bracket minimum size 100 mm

Porte-balai, compatible avec support minimum 100 mm

Toilettenbürstengarnitur verwendbar mit Halter Minimum 100 mm

→ 100 ↑ 395 ↗ 100



52805.29 Portascopino, abbinabile con supporto minimo 100 mm

Toilet brush, matching with bracket minimum size 100 mm

Porte-balai, compatible avec support minimum 100 mm

Toilettenbürstengarnitur verwendbar mit Halter Minimum 100 mm

→ 97 ↑ 410 ↗ 93



SKUARA kit

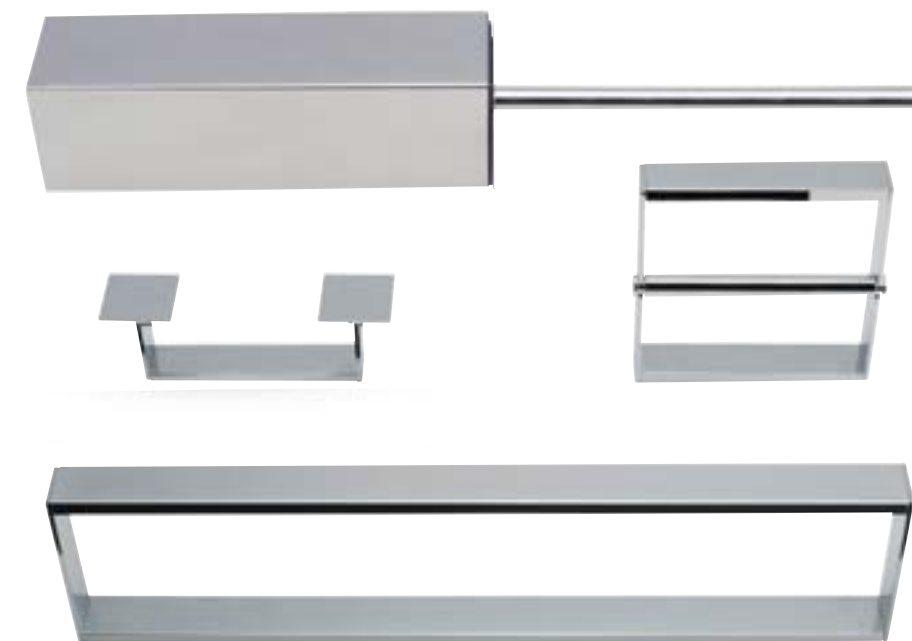

TA-SKUARA FIX

52814.29 / 52853.29 / 52806.29 / 50051.29



TA-SKUARA INCOLLO

ADS.03.52814 / 52814.29 / ADS.01.52853 / 52853.29

ADS.01.52806 / 52806.29 / 50051.29



Esempio di barra attrezzata

Example of equipped rail

Exemple de support équipé

Beispiel für Stange mit Accessoires

52816.29 Supporto / portasalviette

Bracket / towel rail

Support / porte-serviettes

Halter / Handtuchhalter

52804.09 Dosasapone

Soap dispenser

Distributeur savon liquide

Seifenspender

52802.09 Vaschetta portasapone

Soap dish

Porte-savon

Seifenablage

52801.09 Bicchiere

Tumbler

Verre

Becher

BAKETO



Bastoncino (Ba-kè-to).
 Essenzialità per gli spazi più piccoli: una serie completa di accessori, dal portasapone alle mensole alle barre attrezzabili, in ottone cromato, porcellana e vetro.

EN~ *Stick. Minimalism for small spaces: a complete collection of accessories. From porcelain soap holder to glass shelves to chromed brass bars.*

FR~ *Indispensable pour les petits espaces : un ensemble complet d'accessoires, du porte-savon aux étagères et barres à équiper, en laiton chromé, porcelaine et verre.*

DE~ *Wesentlich für kleinere Räume: einen kompletten Satz von Zubehörteilen, von Seife bis zu den Regalen, Stangen mit diversen Ausstattungen, verchromtes Messing, Porzellan und Glas.*



5204.29 Portarotolo

Toilet paper holder
 Porte-rouleau
 Toilettenpapierhalter

→ 155 ↑ 40 ↗ 100



5208.29 Coppia appendini

2 Hooks
 Jeu de 2 patères
 Paar Hacken

∅ 40 ↑ 55



5203.29 Portarotolo coperto

Toilet paper holder with lid
 Porte-rouleau avec couverture
 Toilettenpapierhalter mit Deckel

→ 135 ↑ 80 ↗ 125



Portasalvietta

Towel rail
 Porte-serviettes
 Handtuchhalter

5210.29 → 400 ↑ 40 ↗ 90

5211.29 → 500 ↑ 40 ↗ 90

5212.29 → 600 ↑ 40 ↗ 90



5205.29 Portarotolo doppio

Double toilet paper holder
 Porte-rouleau double
 Toilettenpapierhalter doppelt

→ 265 ↑ 40 ↗ 100



5214.29 Portasalvietta doppio 600 mm

Double towel rail 600 mm
 Porte-serviettes double 600 mm
 Handtuchhalter 600 mm doppelt

→ 600 ↑ 40 ↗ 160



52152.29 Portasalvietta doppio snodato

Double jointed towel rail
Porte-serviettes articulé double
Handtuchhalter doppelt schwenkbar

→ 380 ↑ 150 ↗ 65



52061.29 Supporto portascopino a parete

Wall toilet brush holder

Support porte-balai mural

Halter lose für Toilettenbürsten am Wand

→ 90 ↑ 40 ↗ 130



52153.29 Anello portasalvietta

Towel ring
Anneau porte-serviettes
Handtuchring

∅ 50 ↑ 40 ↗ 95



5216.29 Griglia portasalviette

Towel shelf

Porte-serviettes hotel

Handtuchablage

→ 600 ↑ 40 ↗ 260



52011.29 Supporto singolo

Single holder
Support individuel
Halter lose

∅ 70 ↑ 40 ↗ 120



5234 Coppia supporti mensola
Shelf wall bearing (1 pair)
Paire de supports pour tablette
Paar Halter für Ablage
 Ø 40 ↗ 52

Mensola vetro temperato
Glass shelf
Tablette en verre
Glasablage

5276.81	→ 392	↑ 8	↗ 115
5277.81	→ 492	↑ 8	↗ 115
5278.81	→ 592	↑ 8	↗ 115
5279.81	→ 792	↑ 8	↗ 115



5223.29 Barra attrezzabile
Rail for accessories
Colonne murale à équiper
Stange für Accessoires
 → 40 ↑ 820 ↗ 90



5223.29 Barra attrezzabile 820 mm
Rail for accessories 820 mm
Colonne murale à équiper 820 mm
Stange für Accessoires 820 mm

52241 Supporto per barra
Single holder for rail
Support pour colonne
Halter für Stange

55003.81 Bicchiere
Tumbler
Verre
Becher

5229 Porta salvietta per barra
Towel rail for rail
Porte-serviettes pour colonne
Handtuchhalter für Stange



5223.29 Barra attrezzabile 820 mm
Rail for accessories 820 mm
Colonne murale à équiper 820 mm
Stange für Accessoires 820 mm

5226 Portarotolo per barra
Toilet paper holder for rail
Porte-rouleau pour colonne
Toilettenpapierhalter für Stange

52271 Supporto scopino per barra
Toilet brush holder for rail
Support porte-balai pour colonne
Halter für Stange zu Toilettenbürsten

55062.09 Porta scopino
Toilet brush
Porte-balai
Toilettenbürstengarnitur





5233.29 Griglia portasalviette

Towel rail

Porte-serviettes

Handtuchhalter

→ 465 ↑ 990 ↗ 90



5217.29 Dosasapone a parete 180 ml

Wall soap dispenser 180 ml

Distributeur savon liquide mural 180 ml

Wandseifenspender 180 ml

∅ 50 ↑ 52 ↗ 90



55003 Bicchiere

Tumbler

Verre

Becher

∅ 75 ↑ 105



.09

.80

.81



.09

.80

.81

55006 Dosasapone 200 ml

Soap dispenser 200 ml

Distributeur savon liquide 200 ml

Seifenspender 200 ml

∅ 75 ↑ 185

55004 Portasapone

Soap dish

Porte-savon

Seifenschale

∅ 120 ↑ 30



.09

.80

.81



5200 Griglietta in silicone antiscivolo per Art. 55004 (20 pezzi assortiti in 4 colori)

20 grip grids for soap dish 55004

20 grilles pour porte savon 55004

20 Einlagen für Seifenschale 55004

∅ 50 ↑ 18



BAKETO kit

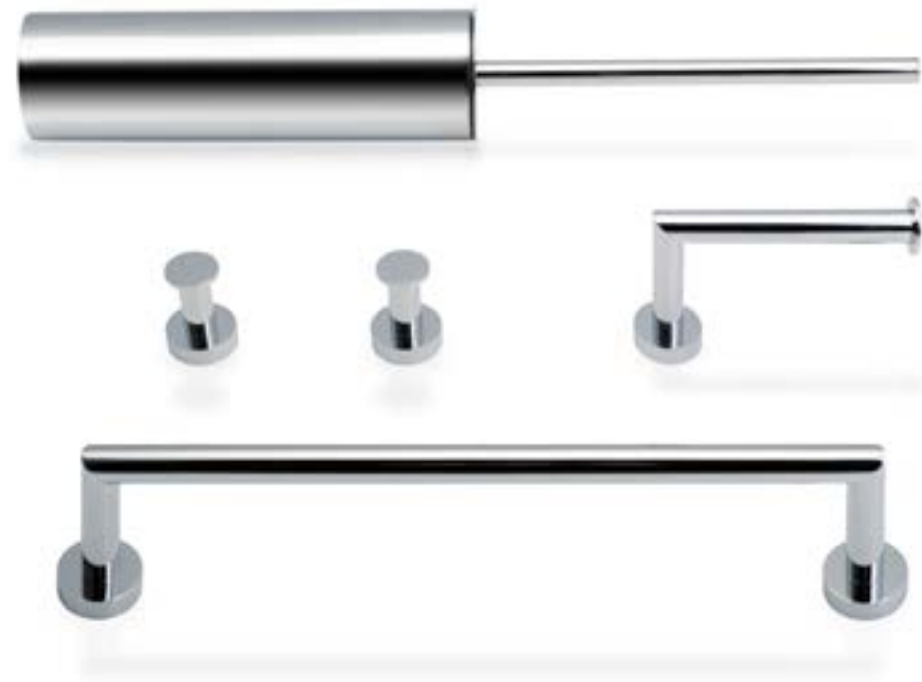

TA-BAKETO FIX

5210.29 / 5208.29 / 5204.29 / 5004.29

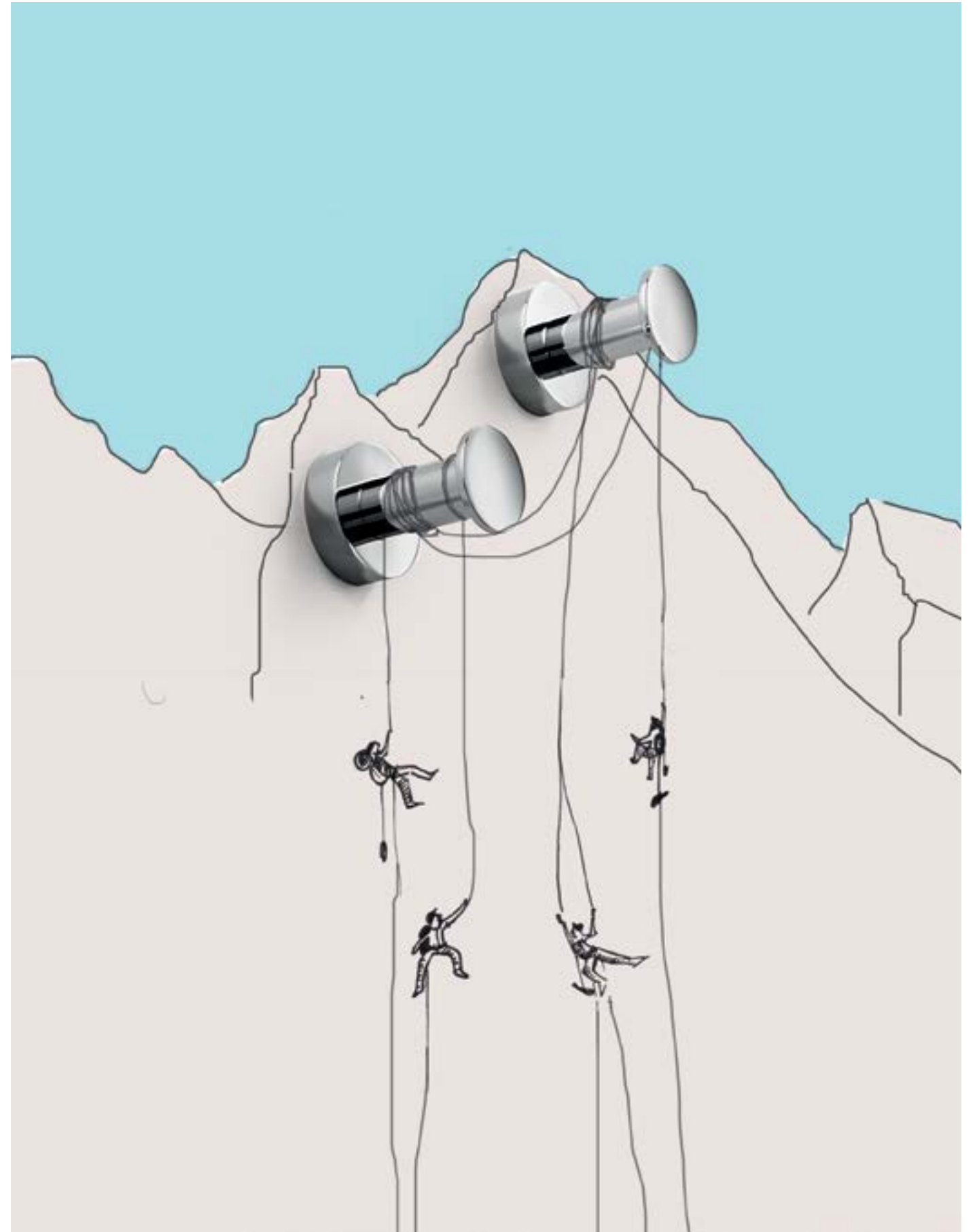

Collezione di accessori a muro in ottone cromato, disponibili con fissaggio ad incollo o viti, dalle barre sottili e longilinee, capaci di mimetizzarsi in ogni ambiente.

EN~ *Two-thousand. Wall chromed brass accessories collection, available with screws or glue wall fixing, with thin and long-limbed bars able to conceal in every bathroom.*

FR~ *Collection d'accessoires muraux en laiton chromé, disponibles avec fixation par collage ou vis, aux barres fines et longilignes, capables de se fondre dans tout environnement.*

DE~ *Sammlung von Wandzubehör aus verchromtem Messing, erhältlich mit Befestigung für Klebstoff oder Schrauben, aus dünnen und langgestreckten Stangen, können in jeder Umgebung angebracht werden.*

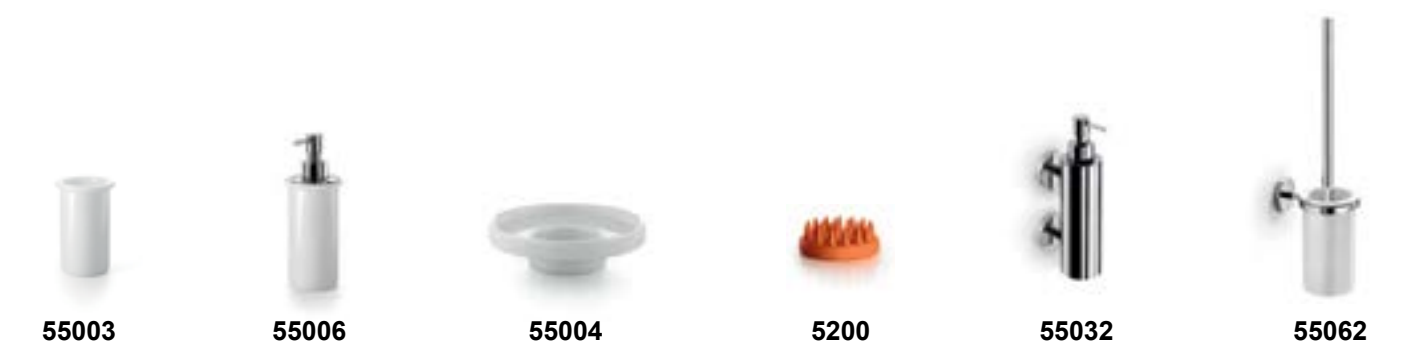
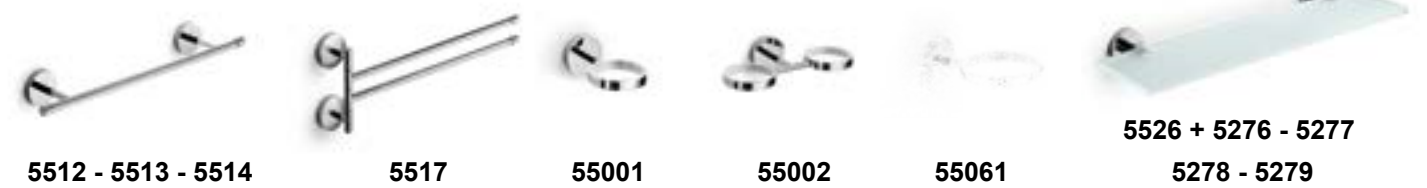
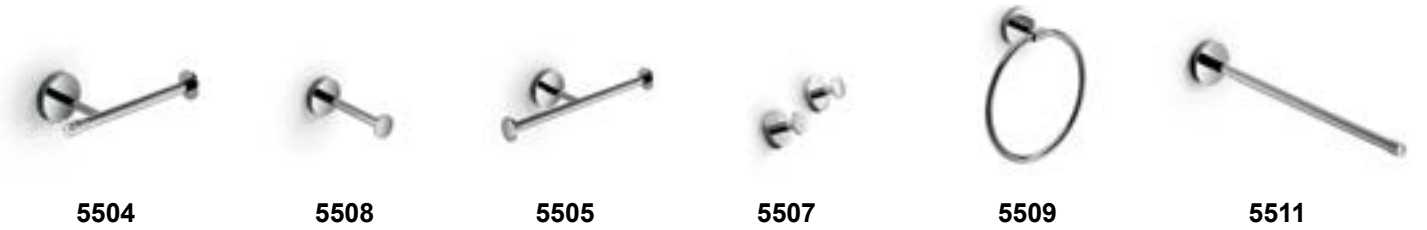

5504.29 Portarotolo

Toilet paper holder
 Porte-rouleau
 Toilettenpapierhalter

→ 160 ↑ 50 ↗ 90



5507.29 Coppia appendini

2 hooks
 Jeu de 2 patères
 Paar Hacken

∅ 50 ↑ 45

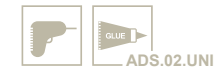

5508.29 Portarotolo

Toilet paper holder
 Porte-rouleau
 Toilettenpapierhalter

∅ 50 ↗ 135



5509.29 Anello portasalvietta

Towel ring
 Anneau porte-serviettes
 Handtuchring

∅ 180 ↑ 200 ↗ 55



5505.29 Portarotolo doppio

Double toilet paper holder
 Porte-rouleau double
 Toilettenpapierhalter doppelt

→ 245 ↑ 50 ↗ 90



5511.29 Portasalvietta 300 mm

Towel rail 300 mm
 Porte-serviettes 300 mm
 Handtuchhalter 300 mm

∅ 50 ↑ 300



Portasalvietta

Towel rail

Porte-serviettes

Handtuchhalter

5512.29 → 400 ↑ 50 ↗ 85

5513.29 → 500 ↑ 50 ↗ 85

5514.29 → 600 ↑ 50 ↗ 85



5517.29 Portasalvietta doppio snodato

Double jointed towel rail

Porte-serviettes articulé double

Doppelter Handtuchhalter schwenkbar

→ 390 ↑ 145 ↗ 50



55001.29 Supporto singolo

Single holder

Support individuel

Halter lose

∅ 70 ↑ 50 ↗ 115



55002.29 Supporto doppio

Double holder

Support double

Halter lose doppelt

→ 200 ↑ 50 ↗ 100



55061.29 Supporto portascopino a parete

Wall toilet brush holder

Support porte-balai mural

Halter lose für Toilettenbürsten am Wand

∅ 90 ↑ 50 ↗ 125



5526 Coppia supporti mensola

Shelf wall bearing (1 pair)

Paire de supports pour tablette

Paar Halter für Ablage

∅ 50 ↑ 40

Mensola vetro temperato

Glass shelf

Tablette en verre

Glasablage

5276.81 → 392 ↑ 8 ↗ 115

5277.81 → 492 ↑ 8 ↗ 115

5278.81 → 592 ↑ 8 ↗ 115

5279.81 → 792 ↑ 8 ↗ 115



55003 Bicchiere

Tumbler

Verre

Becher

∅ 75 ↑ 105



.09 .80 .81



.09 .80 .81

55006 Dosasapone 200 ml

Soap dispenser 200 ml

Distributeur savon liquide 200 ml

Seifenspender 200 ml

∅ 75 ↑ 185



55032.29 Dosasapone 220 ml

Soap dispenser 220 ml

Distributeur savon liquide 220 ml

Wandseifenspender 220 ml

∅ 50 ↑ 200 ↗ 90



ADS.02.UNI

55004 Portasapone

Soap dish

Porte-savon

Seifenschale

∅ 120 ↑ 30



.09 .80 .81



5200 Griglietta in silicone antiscivolo per Art. 55004 (20 pezzi assortiti in 4 colori)

20 grip grids for soap dish 55004

20 grilles pour porte savon 55004

20 Einlagen für Seifenschale 55004

∅ 50 ↑ 18



55062 Portascopino

Toilet brush

Porte-balai

Toilettenbürstengarnitur

∅ 90 ↑ 390



.09 .81

DUEMILA kit

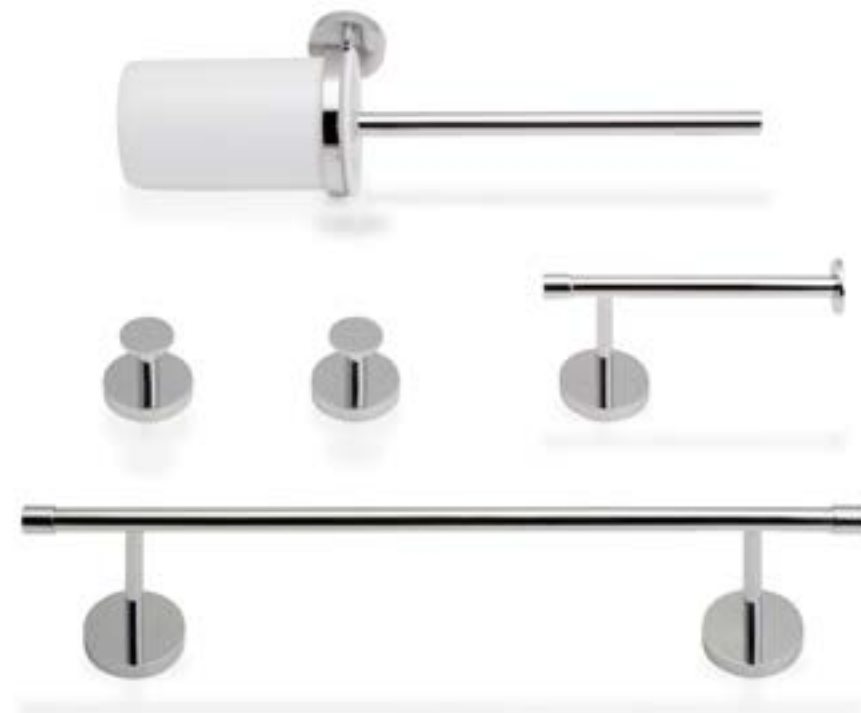

TA-DUEMILA FIX

5512.29 / 5507.29 / 5504.29 / 55061.29+55062.09

DUEMILA BIS kit

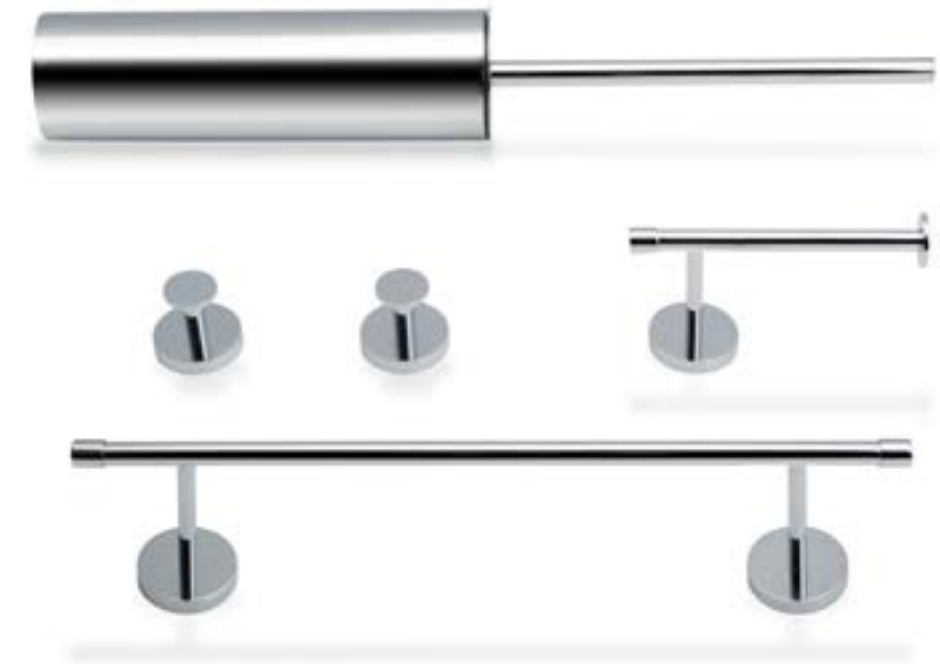

TA-DUEMILA FIX BIS

5512.29 / 5507.29 / 5504.29 / 5004.29



TA-DUEMILA INCOLLO BIS

ADS.02.UNI (X3) / 5512.29 / 5507.29 / 5504.29 / 5004.29

MUCI

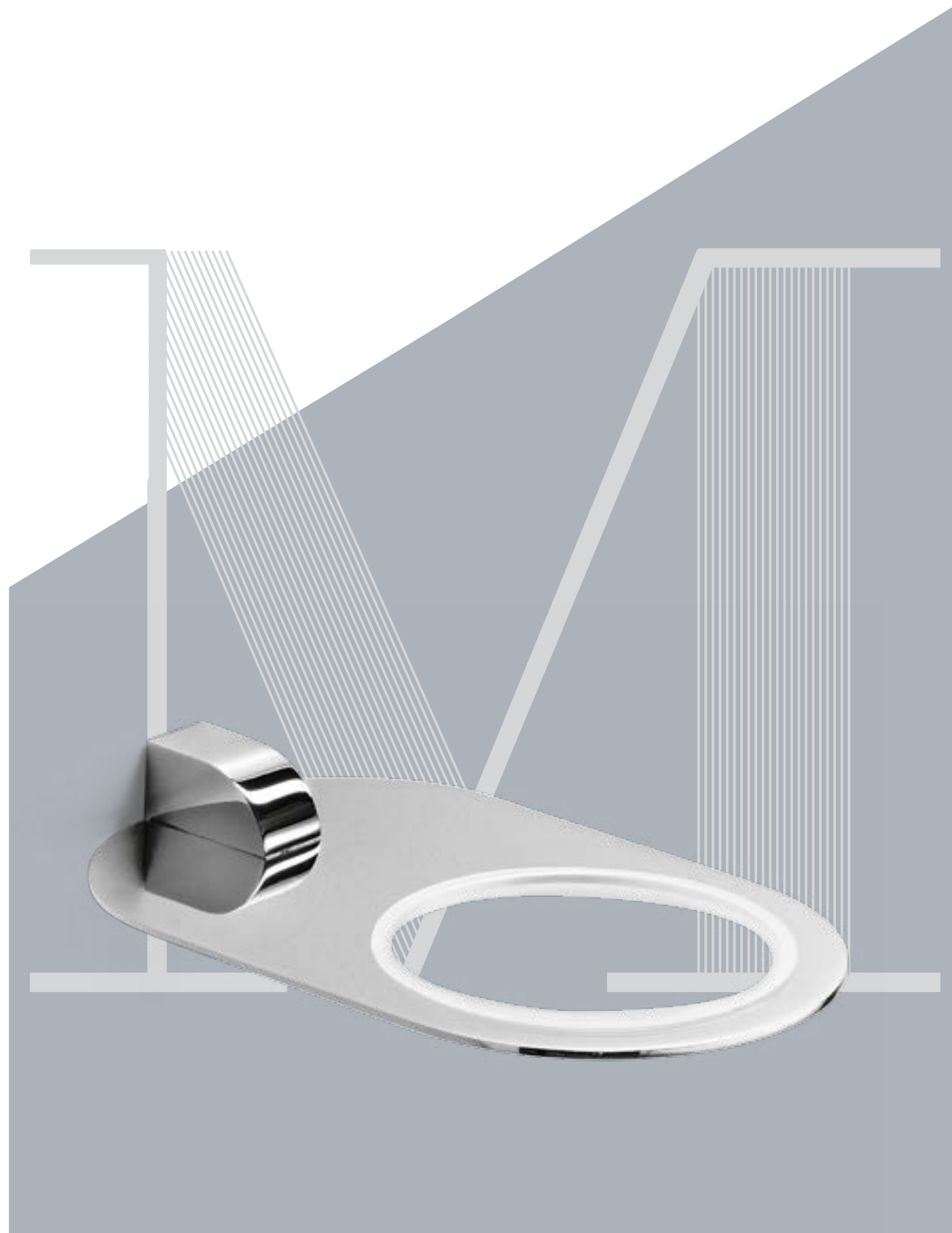

Muci (Mu-cih) Mucchi.
 Spessori e volumi alleggeriti
 per puntare all'essenziale,
 dalle forme curve e morbide.

EN~ *Heap. Lightened thickness and volumes for this collection, aiming to essential with rounded and soft shapes.*

FR~ *Épaisseur et volumes allégés pour se concentrer sur l'essentiel, aux formes douces et arrondies.*

DE~ *Filmdicke und leichtes Volumen zeigen das Wesentliche, mit Kurven und weichen Formen.*

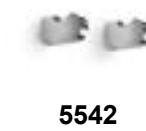

5533.29 Portarotolo

Toilet paper holder

Porte-rouleau

Toilettenpapierhalter

→ 144 ↑ 35 ↗ 85



5542.29 Coppia appendini

2 hooks

Jeu de 2 patères

Paar Hacken

→ 17 ↑ 35 ↗ 50



Portasalvietta

Towel rail

Porte-serviettes

Handtuchhalter

5537.29 → 400 ↑ 35 ↗ 85

5538.29 → 600 ↑ 35 ↗ 85



5539.29 Portasalvietta snodato

Jointed towel rail

Porte-serviettes articulé

Handtuchhalter schwenkbar

→ 380 ↑ 105 ↗ 55



5530.29 Supporto singolo

Single holder

Support individuel

Halter lose

→ 90 ↑ 35 ↗ 135



5536.29 Supporto portascopino a parete

Wall toilet brush holder

Support porte-balai mural

Halter lose für Toilettenbürsten am Wand

→ 110 ↑ 35 ↗ 135



5544 Coppia supporti mensola

Shelf wall bearing (1 pair)

Paire de supports pour tablette

Paar Halter für Ablage

→ 17 ↑ 35 ↗ 35

Mensola vetro temperato

Glass shelf

Tablette en verre

Glasablage

5276.81 → 392 ↑ 8 ↗ 115

5277.81 → 492 ↑ 8 ↗ 115

5278.81 → 592 ↑ 8 ↗ 115

5279.81 → 792 ↑ 8 ↗ 115



55003 Bicchiere

Tumbler
Verre
Becher

∅ 75 ↑ 105



.09 .80 .81

55062 Portascopino

Toilet brush
Porte-balai
Toilettenbürstengarnitur

∅ 90 ↑ 390



.09 .81



.09 .80 .81

55006 Dosasapone 200 ml

Soap dispenser 200 ml
Distributeur savon liquide 200 ml
Seifenspender 200 ml

∅ 75 ↑ 185

55004 Portasapone

Soap dish
Porte-savon
Seifenschale

∅ 120 ↑ 30



.09 .80 .81



5200 Griglietta in silicone antiscivolo per Art. 55004 (20 pezzi assortiti in 4 colori)

20 grip grids for soap dish 55004
20 grilles pour porte savon 55004
20 Einlagen für Seifenschale 55004

∅ 50 ↑ 18



MUCI kit

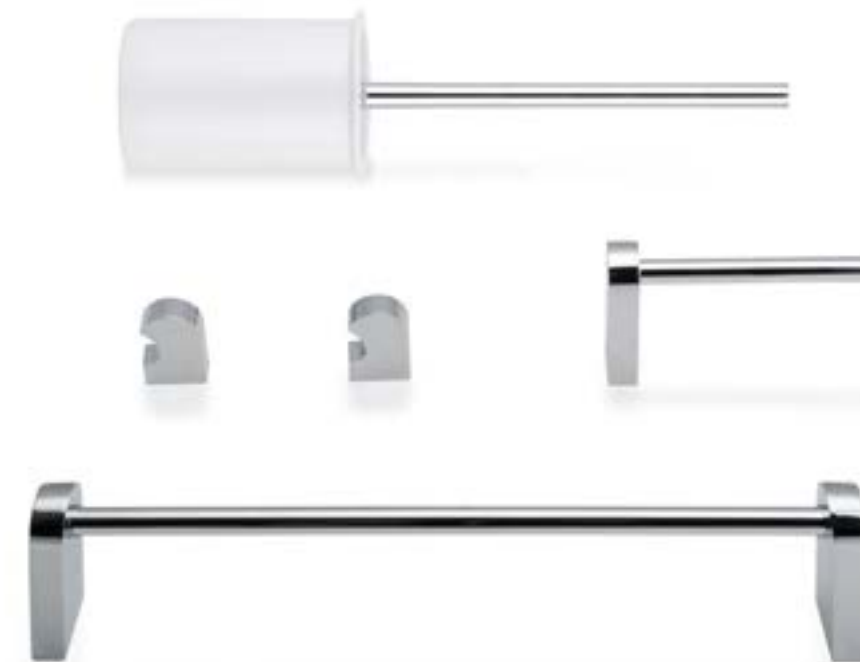

TA-MUCI FIX

5537.29 / 5542.29 / 5533.29 / 55062.09

PICOLA

Piccola. Linea di accessori in ottone cromato: passe-partout versatili e molto adatti ai piccoli spazi, dalle forme essenziali e non subordinate agli stili e alle tendenze del momento.

EN~ *Small. Chromed brass collection of versatile design for small spaces. Essential forms not bounded to style or trends.*

FR~ *Ligne d'accessoires en laiton chromé : passe-partout polyvalent et très adapté aux espaces réduits, aux formes basiques et non soumises aux styles et tendances du moment.*

DE~ *Linie aus verchromtem Messing und Zubehör: Matte vielseitig und gut geeignet für kleine Räume, mit einer Grundform, die sich nicht dem Stil und den Trends des Augenblicks unterordnet.*





5254.29 Portarotolo

Toilet paper holder
Porte-rouleau
Toilettenpapierhalter

→ 20 ↑ 35 ↗ 125



52535.29 Portarotolo

Toilet paper holder
Porte-rouleau
Toilettenpapierhalter

→ 136 ↑ 60 ↗ 90



5258.29 Coppia appendini

2 hooks
Jeu de 2 patères
Paar Hacken

→ 20 ↑ 390 ↗ 50

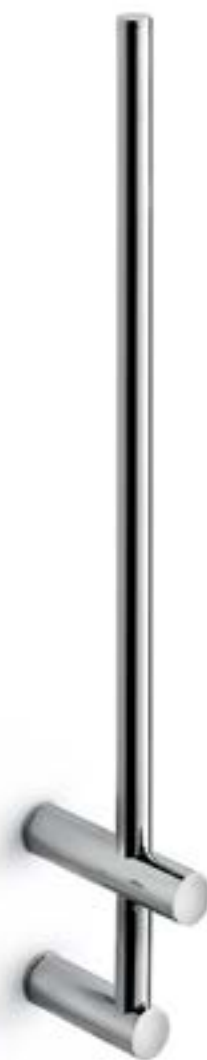

5255.29 Portarotolo con riserva

Toilet paper holder with reserve
Porte-rouleau réserve
Toilettenpapier Ersatzrollenhalter

→ 20 ↑ 400 ↗ 92



5259.29 Anello portasalvietta

Towel ring
Anneau porte-serviettes
Handtuchring

→ 180 ↑ 185 ↗ 50



Portasalvietta

Towel rail
Porte-serviettes
Handtuchhalter

5260.29 → 400 Ø 20 ↗ 80

5262.29 → 600 Ø 20 ↗ 80

5263.29 → 700 Ø 20 ↗ 80



5264.29 Portasalvietta doppio

Double towel rail
Porte-serviettes double
Handtuchhalter doppelt

→ 600 Ø 20 ↗ 125



5265.29 Portasalvietta snodato*Jointed towel rail**Porte-serviettes articulé**Handtuchhalter schwenkbar*

→ 370 ↑ 140 ↗ 54

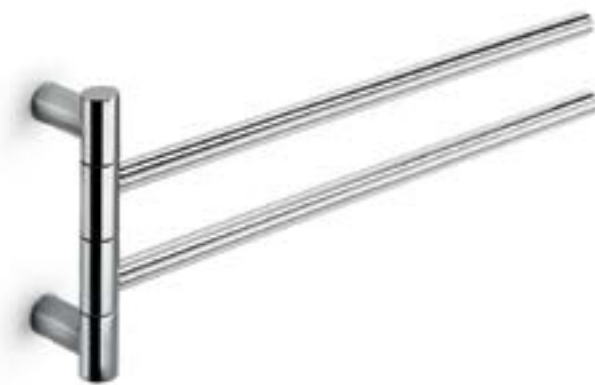
**52511.29 Supporto singolo***Single holder**Support individuel**Halter lose*

∅ 70 ↑ 40 ↗ 120

**52561.29 Supporto portascopino a parete***Wall toilet brush holder**Support porte-balai mural**Halter lose für Toilettenbürsten am Wand*

∅ 90 ∅ 20 ↗ 130

**5273.29 Coppia supporti mensola***Shelf wall bearing (1 pair)**Paire de supports pour tablette**Paar Halter für Ablage*

∅ 20 ↗ 30

Mensola vetro temperato*Glass shelf**Tablette en verre**Glasablage***5276.81** → 392 ↑ 8 ↗ 115**5277.81** → 492 ↑ 8 ↗ 115**5278.81** → 592 ↑ 8 ↗ 115**5279.81** → 792 ↑ 8 ↗ 115**55062 Portascopino***Toilet brush**Porte-balai**Toilettenbürstengarnitur*

∅ 90 ↑ 390



55003 Bicchiere

Tumbler

Verre

Becher

∅ 75 ↑ 105



.09 .80 .81

55006 Dosasapone 200 ml

Soap dispenser 200 ml

Distributeur savon liquide 200 ml

Seifenspender 200 ml

∅ 75 ↑ 185



.09 .80 .81

55004 Portasapone

Soap dish

Porte-savon

Seifenschale

∅ 120 ↑ 30



.09 .80 .81



5200 Griglietta in silicone antiscivolo per Art. 55004 (20 pezzi assortiti in 4 colori)

20 grip grids for soap dish 55004

20 grilles pour porte savon 55004

20 Einlagen für Seifenschale 55004

∅ 50 ↑ 18



52510.29 Borchia per serie 'PICOLA'

Plate for 'PICOLA' range

Plaque murale collection 'PICOLA'

Scheibe für Serie 'PICOLA'

∅ 40 ↑ 2



PICOLA kit



TA-PICOLA FIX

5260.29 / 5258.29 / 52535.29 / 5004.29

Dotato di un grande naso. Collezione di accessori dalla solidità massiccia. Supporti, porta salviette e tanto altro, tutto in ottone cromato.

EN~ *Person with a big nose. A collection of accessories featuring robust solidity. Supports, towel racks and much more, all in chrome-plated brass.*

FR~ *Collection d'accessoires extrêmement solides. Supports, porte-serviettes et bien d'autres, le tout en laiton chromé.*

DE~ *Sammlung von Zubehör mit massiver Solidität. Halter, Handtuchhalter und vieles mehr, alles in Messing verchromt.*

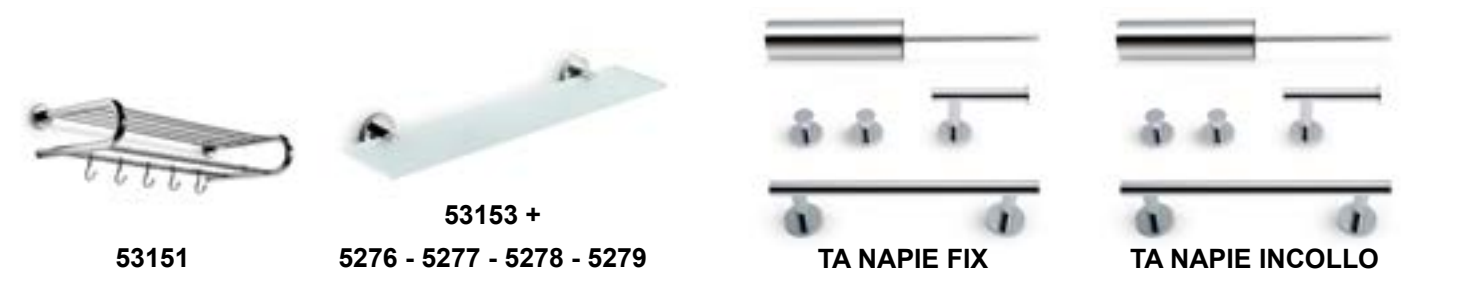
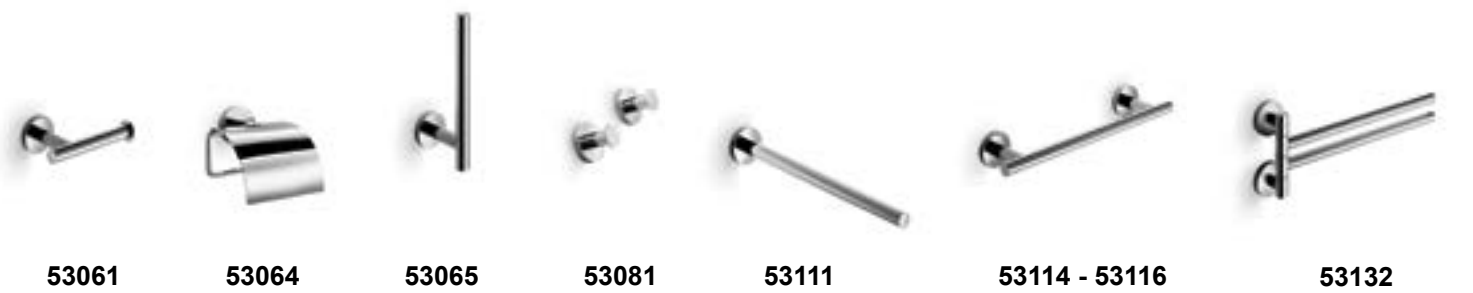
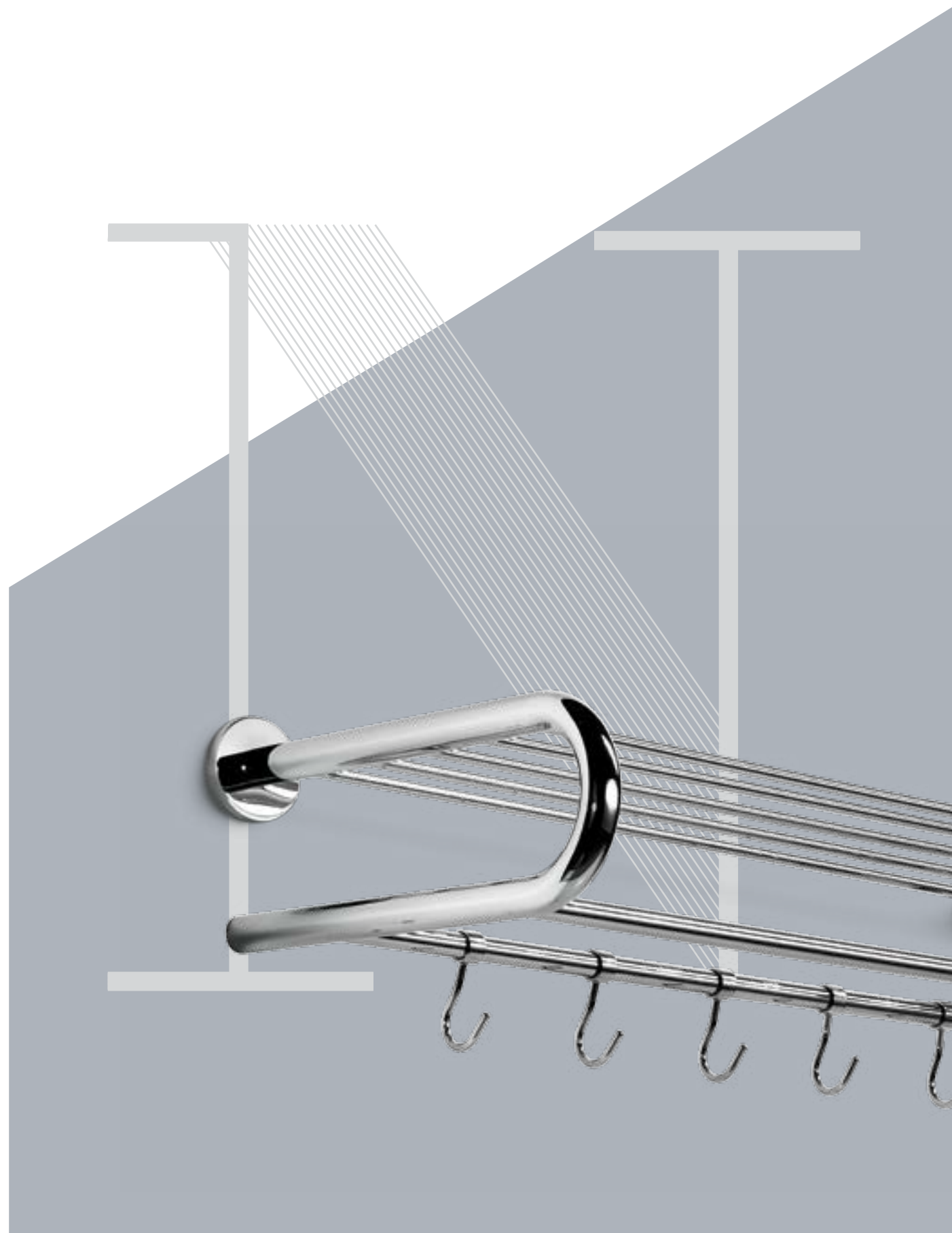

53061.29 Portarotolo

Toilet paper holder
 Porte-rouleau
 Toilettenpapierhalter

→ 165 ↑ 60 ↗ 110



53064.29 Portarotolo con coperchio mobile

Toilet paper holder with movable lid
 Porte-rouleau avec couverture meuble
 Toilettenpapierhalter mit verschiebarem Deckel

→ 135 ↑ 160 ↗ 80



53065.29 Portarotolo con riserva

Toilet paper holder with reserve
 Porte-rouleau réserve
 Toilettenpapier Ersatzrollenhalter

→ 60 ↑ 260 ↗ 100



53081.29 Coppia appendini singoli

2 hooks
 Paire de patère
 Paar Hacken

Ø 60 ↑ 50



53111.29 Portasalvietta

Towel rail
 Porte-serviettes
 Handtuchhalter

Ø 60 ↑ 360



Portasalvietta

Towel rail
 Porte-serviettes
 Handtuchhalter

53114.29 → 400 ↑ 60 ↗ 90

53116.29 → 600 ↑ 60 ↗ 90





53132.29 Portasalvietta snodato

Jointed towel rail

Porte-serviettes articulé

Handtuchhalter schwenkbar

→ 60 ↑ 360 ↗ 52



44070.29 Ghiera per accessori serie 'NAPIE' da appoggio

Ring for tabletop 'NAPIE' accessories

Anneau pour accessoires d'appui 'NAPIE'

Ring für Accessories am Boden Serie 'NAPIE'

∅ 70 ↑ 25



53011.29 Supporto singolo

Single holder

Support individuel

Halter lose

∅ 70 ↑ 60 ↗ 115



53066.29 Supporto portascopino a parete

Wall toilet brush holder

Support porte-balai mural

Halter lose für Toilettenbürsten am Wand

∅ 90 ↑ 60 ↗ 125



53020 Bicchiere

Tumbler

Verre

Becher

∅ 80 ↑ 105



.09

.29

.81



.09

.29

.81

53022 Dosasapone 300 ml

Soap dispenser 300 ml

Distributeur savon liquide 300 ml

Seifenspender 300 ml

∅ 80 ↑ 165

53021 Portasapone

Soap dish

Porte-savon

Seifenschale

∅ 120 ↑ 45



.09

.29

.81



.09

.81

55062 Portascopino

Toilet brush

Porte-balai

Toilettenbürstengarnitur

∅ 90 ↑ 390

53141.29 Griglia portasalviette

Towel shelf
Porte-serviettes hotel
Handtuchablage

→ 600 ↑ 60 ↗ 300



53151.29 Griglia con portasalvietta

Shelf with towel rail
Porte-serviettes hotel avec barre
Handtuchablage

→ 700 ↑ 140 ↗ 310



53153 Coppia supporti mensola

Shelf wall bearing (1 pair)
Paire de supports pour tablette
Paar Halter für Ablage

⊙ 60 ↗ 45

Mensola vetro temperato

Glass shelf
Tablette en verre
Glasablage

5276.81 → 392 ↑ 8 ↗ 115

5277.81 → 492 ↑ 8 ↗ 115

5278.81 → 592 ↑ 8 ↗ 115

5279.81 → 792 ↑ 8 ↗ 115



NAPIE kit

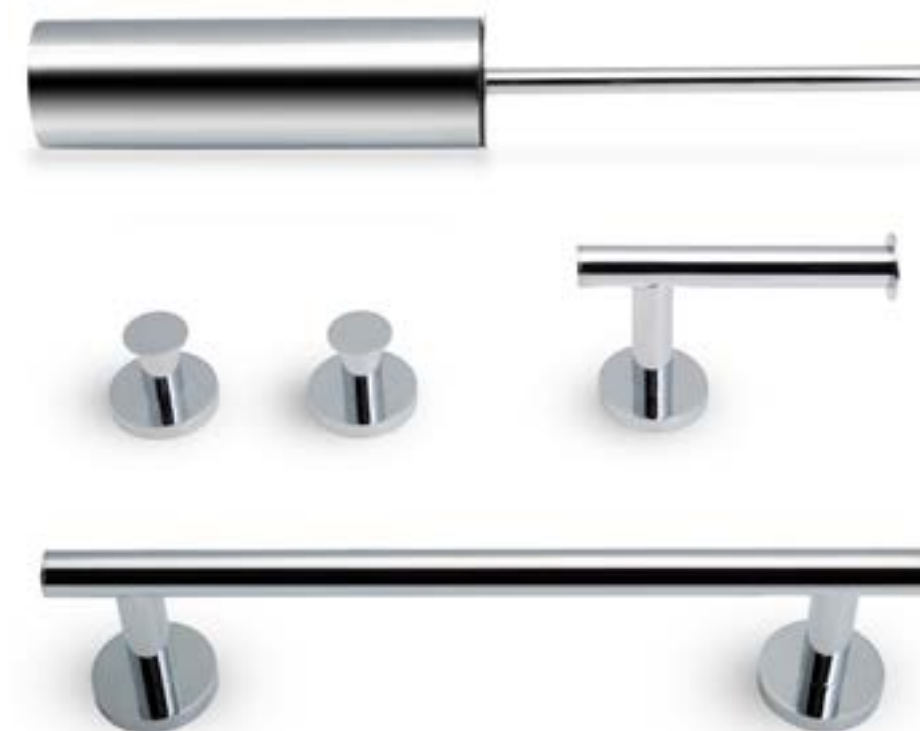

TA-NAPIE FIX

53114.29 / 53081.29 / 53061.29 / 5004.29



TA-NAPIE INCOLLO

ADS.02.UNI (X3) / 53114.29 / 53081.29 / 53061.29 / 5004.29

VENESSIA

Venezia. Linee eleganti, rigorose, e richiami a un grande passato in ottone cromato: anche la rigidità può accompagnarsi a forme dal sapore antico e ricercato.

EN~ Venice. Elegant, precise lines and features from a great past of chrome-plated brass: even precision can be combined with shapes in an old and sophisticated style.

FR~ Des lignes élégantes, rigoureuses, et des rappels d'un grand passé en laiton chromé : même la rigueur peut s'accompagner de formes au goût ancien et raffiné.

DE~ Des lignes élégantes, rigoureuses, et des rappels d'un grand passé en laiton chromé : même la rigueur peut s'accompagner de formes au goût ancien et raffiné.

FINITURE / Finishing / Finitions / Oberflächen



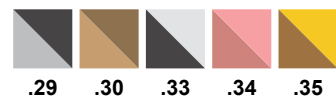

52908 Portarotolo

Toilet paper holder

Porte-rouleau

Toilettenpapierhalter

→ 160 ↑ 120 ↗ 65

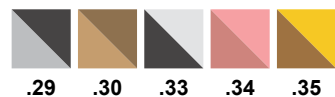

52907 Portarotolo con coperchio mobile

Toilet paper holder with movable lid

Porte-rouleau avec couverture mobile

Toilettenpapierhalter mit verschiebarem Deckel

→ 57 ↑ 138 ↗ 100

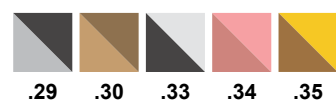

52910 Portarotolo con riserva

Toilet paper holder with reserve

Porte-rouleau réserve

Toilettenpapier Ersatzrollenhalter

∅ 60 ↑ 295 ↗ 85

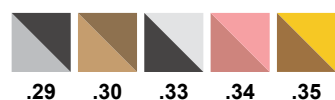

52938 Appendino

Hook

Patère

Hacken

∅ 57 ↑ 138 ↗ 100

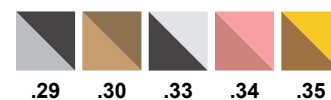

52939 Appendino doppio

Double hook

Patère double

Handtuchhaken doppelt

→ 120 ↑ 95 ↗ 65

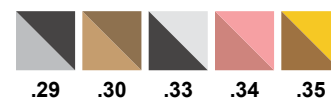

52921 Anello portasalvietta

Towel ring

Anneau porte-serviettes

Handtuchring

→ 200 ↑ 222 ↗ 85

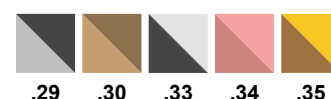

Portasalvietta

Towel holder

Porte-serviettes

Handtuchhalter

52914 → 457 ↑ 57 ↗ 85

52916 → 657 ↑ 57 ↗ 85



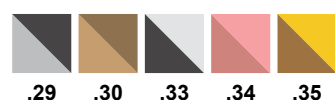

52917 Portasalvietta doppio

Double towel holder

Porte-serviettes doble

Handtuchhalter doppelt

→ 660 ↑ 120 ↗ 165

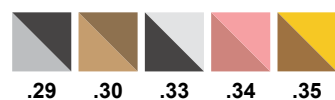

52920 Portasalvietta snodato

Jointed towel rail

Porte-serviettes articulé

Handtuchhalter schwenkbar

→ 340 ↑ 235 ↗ 65

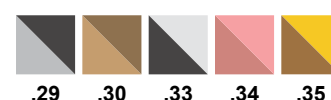

52901 Portabicchiere con bicchiere in porcellana

Holder with porcelain tumbler

Support avec verre en porcelaine

Halter mit Becher aus Porzellan

∅ 83 ↑ 145 ↗ 150

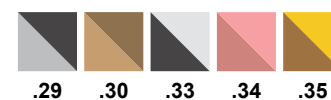

52902 Portasapone con piattino in porcellana

Holder with porcelain soap dish

Support avec porte-savon en porcelaine

Halter mit Seifenschale aus Porzellan

→ 150 ↑ 75 ↗ 130

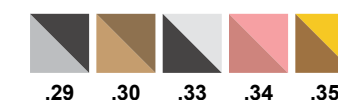

52906 Portascopino a parete con vaso in porcellana

Wall holder with porcelain toilet brush

Support avec porte-balai en porcelaine

Wandhalter mit Toilettenbürstengarnitur aus Porzellan

∅ 90 ↑ 385 ↗ 165



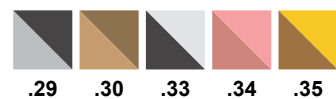

52926 Griglia con portasalvietta

Shelf with towel holder
Porte-serviettes hotel avec barre
Handtuchablage mit Handtuchhalter
 → 657 ↑ 140 ↗ 220

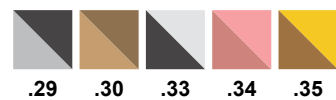

52932 Coppia supporti mensola

Shelf wall bearing (1 pair)
Paire de supports pour tablette
Paar Halter für Ablage
 Ø 57 ↗ 30

Mensola vetro temperato

Glass shelf
Tablette en verre
Glasablage

5276.81 → 392 ↑ 8 ↗ 115

5277.81 → 492 ↑ 8 ↗ 115

5278.81 → 592 ↑ 8 ↗ 115

5279.81 → 792 ↑ 8 ↗ 115



52924 Traversa vasca

Bathtub bridge
Porte-objets transversal pour baignoire
Badewannenauflage
 → 200 ↑ 222 ↗ 85

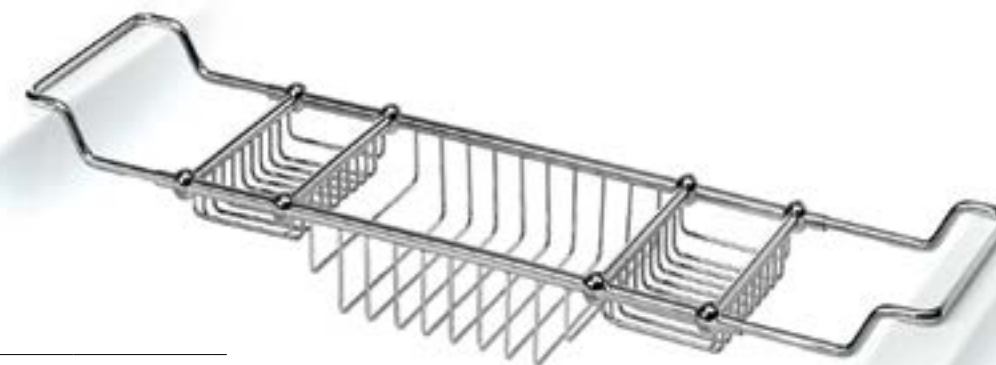

VENESSIA kit



TA-VENESSIA FIX

52914.29 / 52939.29 / 52908.29 / 52906.29



TA-VENESSIA INCOLLO

ADS.02.UNI (X3) / 52914.29 / 52939.29 / 52908.29 / 52906.29

KIT TAKE AWAY



Kit base composti da accessori ad incollo o fissaggio con viti.

EN~ Basic accessories kits, screw of blue fixing.

FR~ Ensembles composé des accessoires de base, pour fixation avec vis ou adhésif 3M.

DE~ Die Sätze bestehen aus grundlegendes Artikel, die geklebt oder angeschraubt werden können.

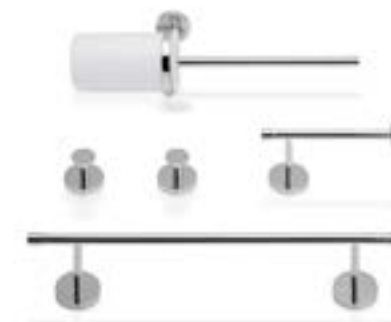

TA-DUEMILA FIX

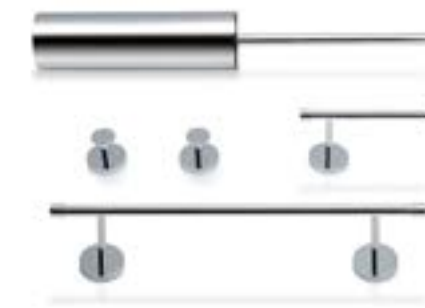

TA-DUEMILA FIX BIS
TA-DUEMILA INCOLLO BIS

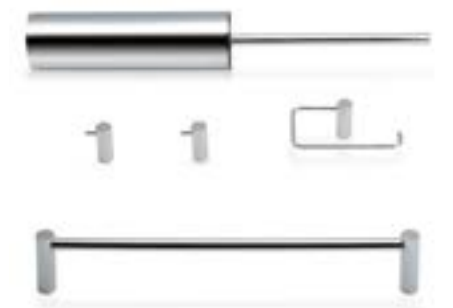

TA-PICOLA FIX

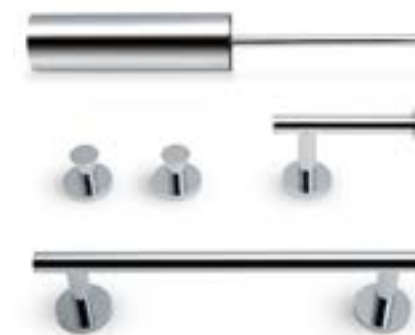

TA-NAPIE FIX
TA-NAPIE INCOLLO

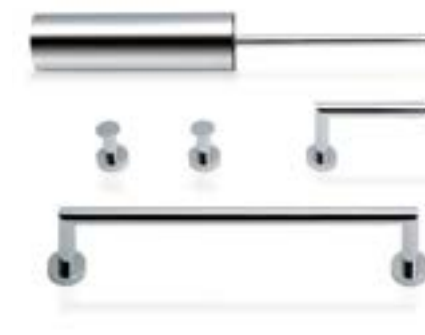

TA-BAKETO FIX

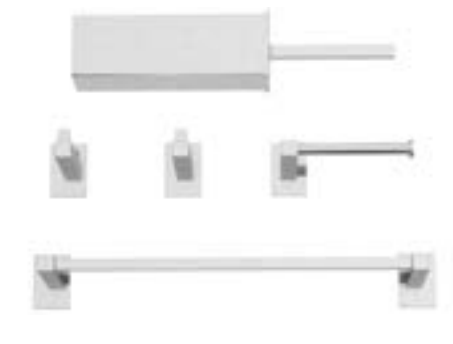

TA-TACÀ INCOLLO



TA-VENESSIA FIX
TA-VENESSIA INCOLLO

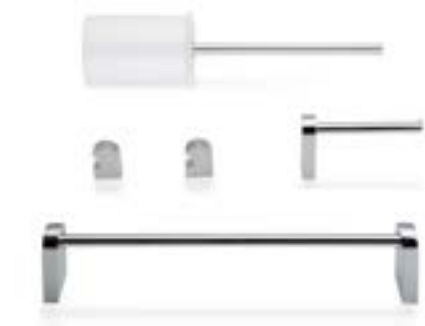

TA-MUCI FIX

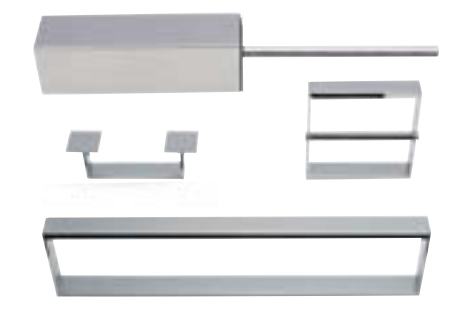

TA-SKUARA FIX
TA-SKUARA INCOLLO

DUEMILA kit

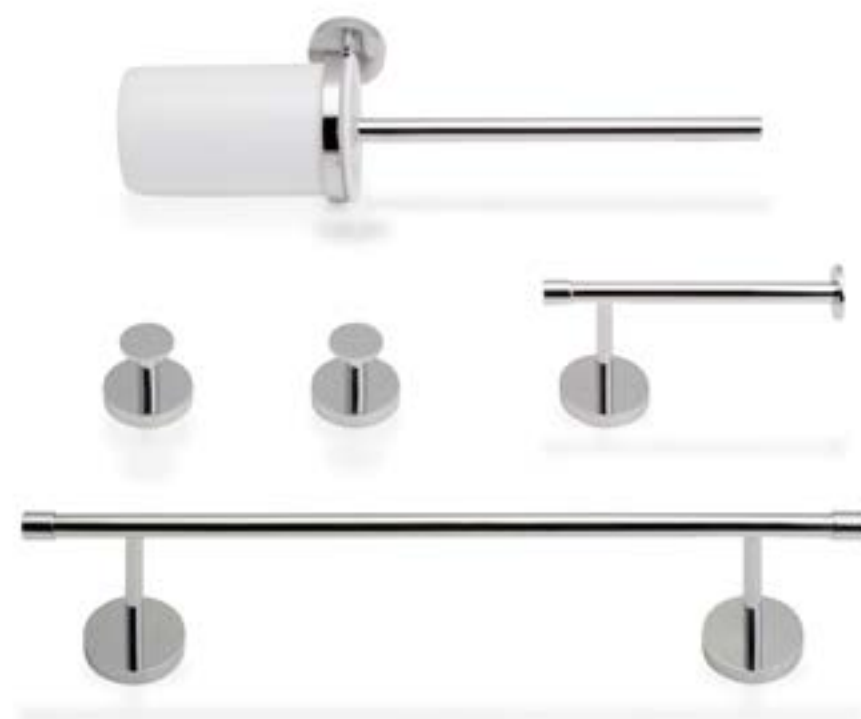

TA-DUEMILA FIX

5512.29 / 5507.29 / 5504.29 / 55061.29+55062.09

DUEMILA BIS kit

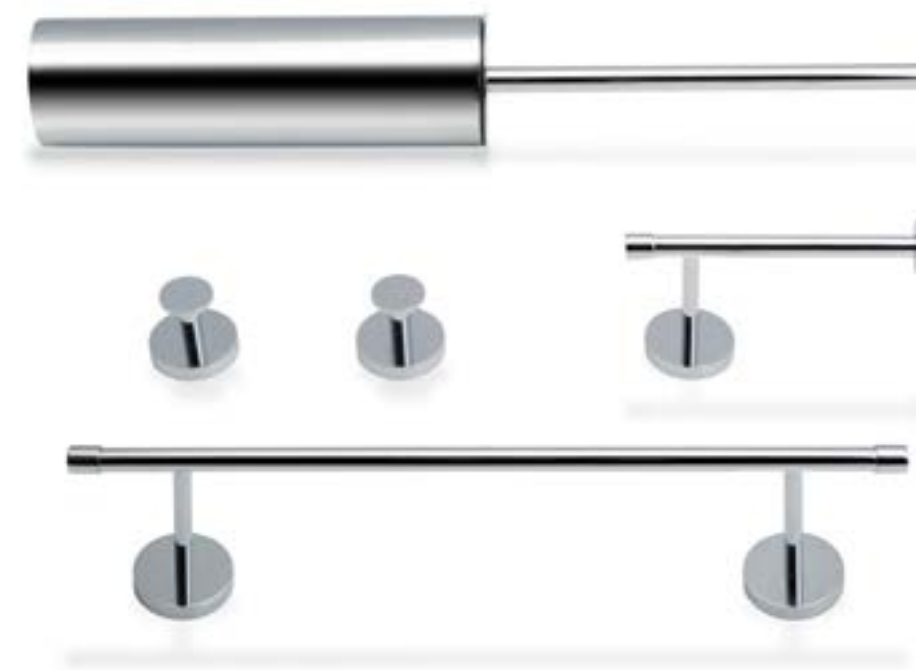

TA-DUEMILA FIX BIS

5512.29 / 5507.29 / 5504.29 / 5004.29



TA-DUEMILA INCOLLO BIS

ADS.02.UNI (X3) / 5512.29 / 5507.29 / 5504.29 / 5004.29

PICOLA kit

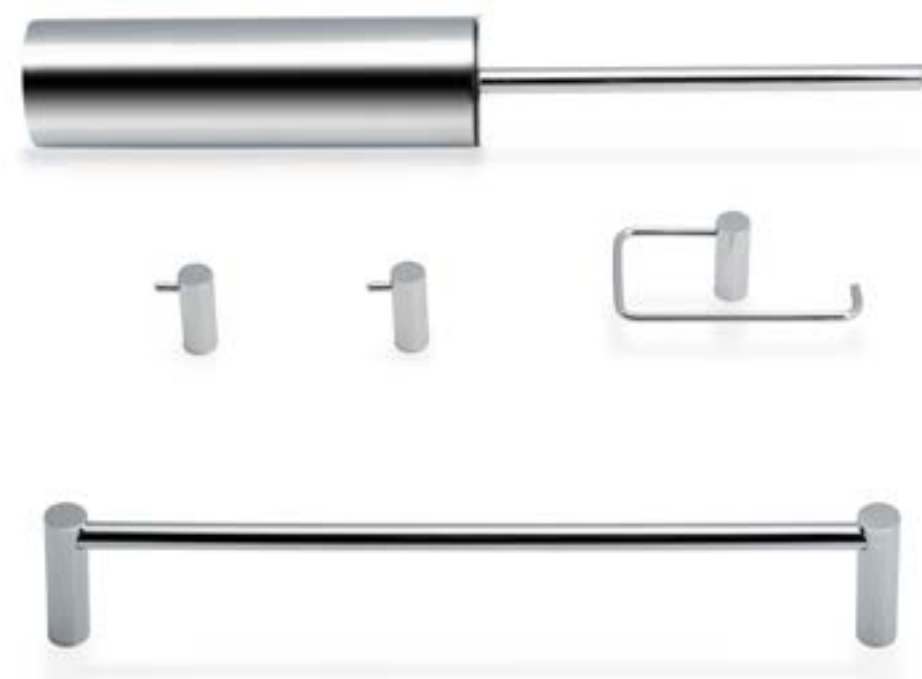

TA-PICOLA FIX

5260.29 / 5258.29 / 52535.29 / 5004.29

NAPIE kit

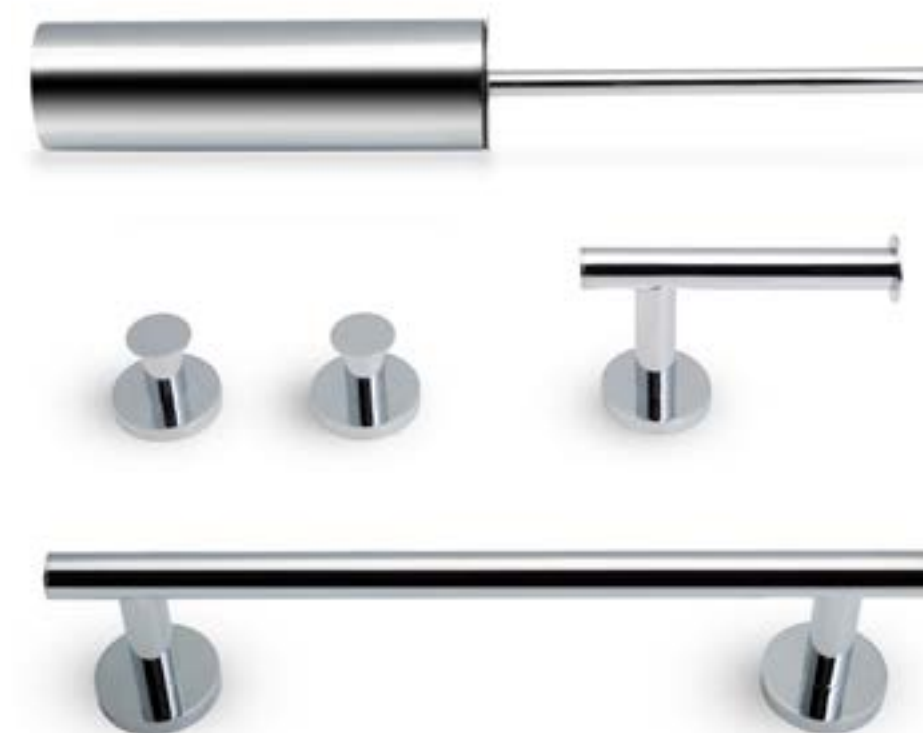

TA-NAPIE FIX

53114.29 / 53081.29 / 53061.29 / 5004.29



TA-NAPIE INCOLLO

ADS.02.UNI (X3) / 53114.29 / 53081.29 / 53061.29 / 5004.29

BAKETO kit

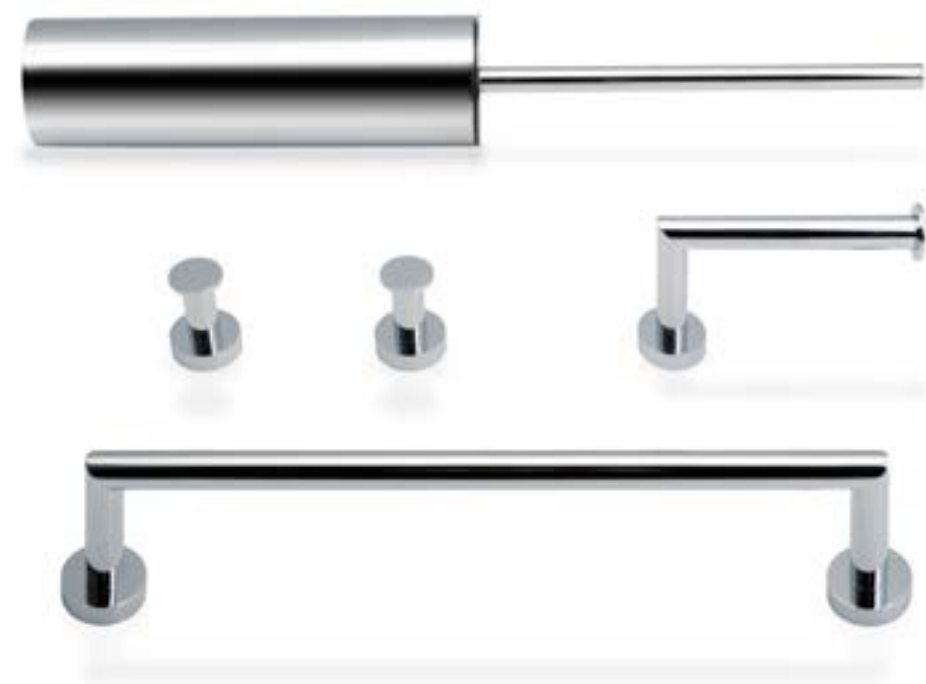

TA-BAKETO FIX

5210.29 / 5208.29 / 5204.29 / 5004.29

TACÀ kit

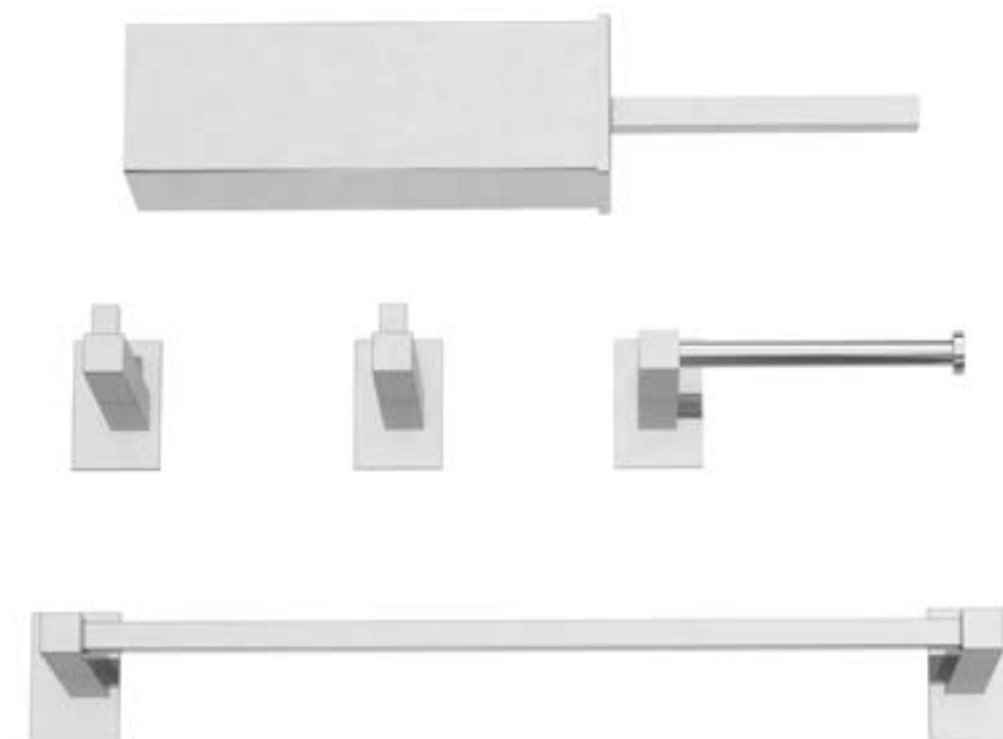

TA-TACÀ INCOLLO

51905.29 / 51902.29 (X2) / 51901.29 / 50054.29

VENESSIA kit

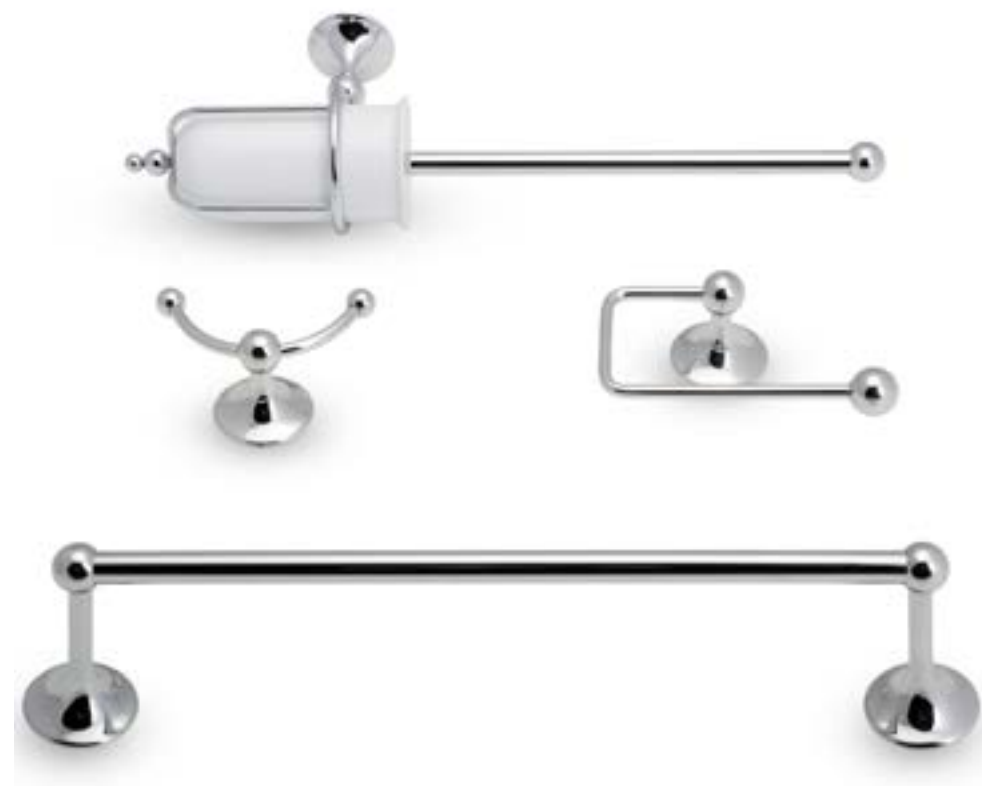

TA-VENESSIA FIX

52914.29 / 52939.29 / 52908.29 / 52906.29



TA-VENESSIA INCOLLO

ADS.02.UNI (X3) / 52914.29 / 52939.29 / 52908.29 / 52906.29

MUCI kit

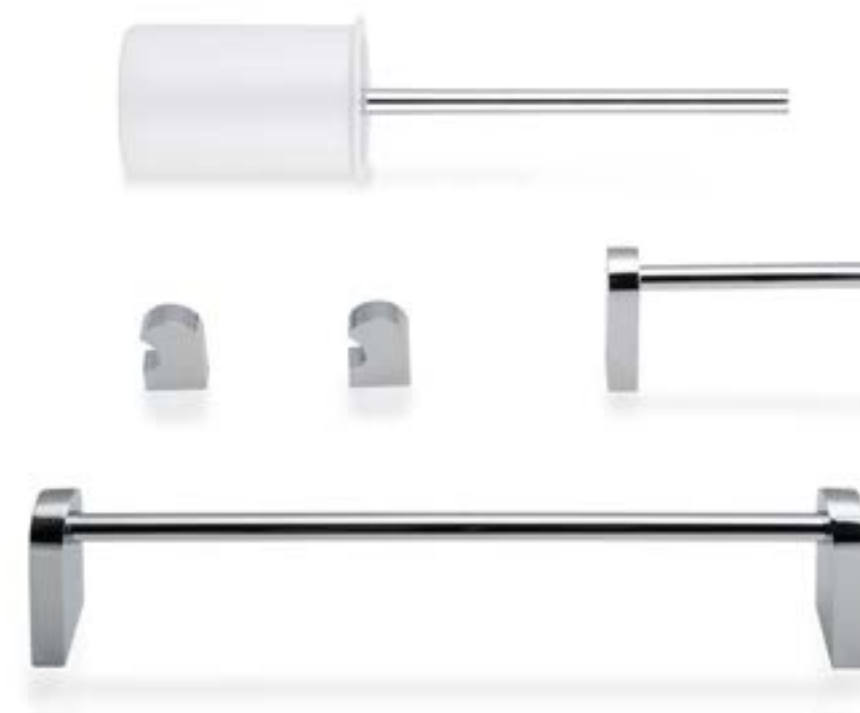

TA-MUCI FIX

5537.29 / 5542.29 / 5533.29 / 55062.09

SKUARA kit

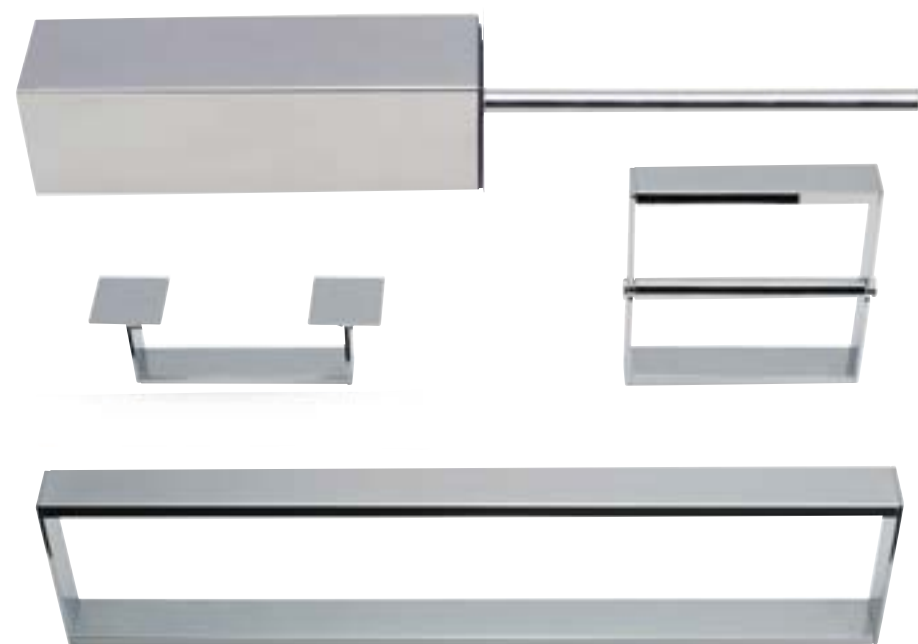

TA-SKUARA FIX

52814.29 / 52853.29 / 52806.29 / 50051.29



TA-SKUARA INCOLLO

ADS.03.52814 / 52814.29 / ADS.01.52853 / 52853.29
ADS.01.52806 / 52806.29 / 50051.29



Collezione Accessori Appoggio
Tabletop Accessories Collection
Collection Accessoires à Poser
Kollektion Zubehöre zum Stand

SAON

Accessori appoggio / *Tabletop accessories /*
Accessoires à poser / Zubehöre zum Stand

167

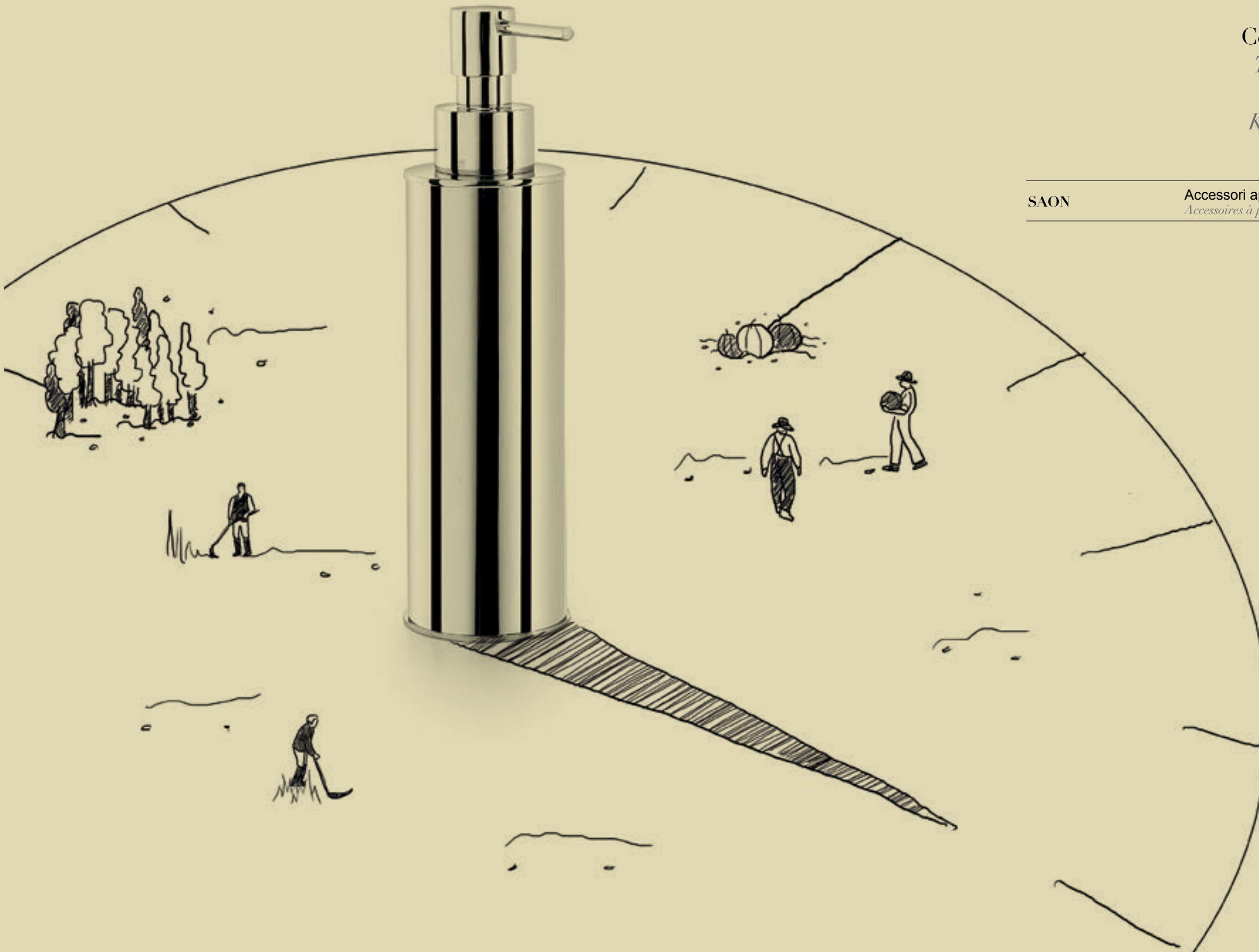

SAON



Sapone. Completa collezione di accessori da appoggio abbinabili alle collezioni a muro o ai mobili e lavabi. Forme tonde, rettangolari e particolari, realizzati nei materiali più vari, fra i quali vetro, acciaio inox, porcellana e ABS.

EN~ Soap. Complete collection of accessories matching with wall collections, furniture and washbasins. Designed with round, square and particular shapes and in different materials, such as glass, stainless steel, ABS plastic and porcelain.

FR~ Collection complète d'accessoires de support, associables aux collections murales ou au meubles et lavabos. Formes arrondies, rectangulaires et détails, réalisés dans divers matériaux, dont le verre, l'acier inox, la porcelaine et l'ABS.

DE~ Vollständige Sammlung von Accessoires, die kombiniert werden können mit Kollektionen für die Wand oder um Möbel und Waschbecken zu gestalten. Runde oder rechteckige Formen können in den verschiedensten Materialien realisiert werden, einschließlich Glas, Edelstahl, Porzellan und ABS.



44021 44022 44023 44024 44031 44032 44033 44034 44041



44025 4400 4412 4413 4414 44281 3901 4072 44018



55003 55004 5200 55006 44070 53020 53021 53022 44019 44020

44021.09 Bicchiere in porcellana

Porcelain tumbler

Verre en porcelaine

Becher aus Porzellan

∅ 80 ↑ 100



44024.09 Dosasapone 400 ml in porcellana

Porcelain soap dispenser 400 ml

Distributeur savon liquide 400 ml en porcelaine

Seifenspender 400 ml aus Porzellan

∅ 80 ↑ 170



44022.09 Portasapone in porcellana

Porcelain soap dish

Porte-savon en porcelaine

Seifenablage aus Porzellan

∅ 115 ↑ 30



44031.09 Bicchiere in porcellana

Porcelain tumbler

Verre en porcelaine

Becher aus Porzellan

→ 90 ↑ 105 ↗ 65



44023.09 Dosasapone 500 ml in porcellana

Porcelain soap dispenser 500 ml

Distributeur savon liquide 500 ml en porcelaine

Seifenspender 500 ml aus Porzellan

∅ 100 ↑ 140



44032.09 Portasapone in porcellana

Porcelain soap dish

Porte-savon en porcelaine

Seifenablage aus Porzellan

→ 135 ↑ 30 ↗ 90





44033.09 Dosasapone 400 ml in porcellana

Porcelain soap dispenser 400 ml
Distributeur savon liquide 400 ml en porcelaine
Seifenspender 400 ml aus Porzellan

→ 65 ↑ 185 ↗ 65



44034.09 Dosasapone 600 ml in porcellana

Porcelain soap dispenser 600 ml
Distributeur savon liquide 600 ml en porcelaine
Seifenspender 600 ml aus Porzellan

→ 90 ↑ 185 ↗ 65



4400.29 Dosasapone 220 m

Soap dispenser 220 ml
Distributeur savon liquide 220 ml
Seifenspender 220 ml

∅ 55 ↑ 200



44041.19 Dosasapone 500 ml in ceramica

Porcelain soap dispenser 500 ml
Distributeur savon liquide 500 ml en céramique
Seifenspender 500 ml aus Keramik

→ 83 ↑ 180 ↗ 73



44025.09 Tazza portaspazzolini in ceramica

Porcelain toothbrush holder mug
Porte-brosses à dents en céramique
Zahnputztasse aus Keramik

→ 80 ↑ 100 ↗ 110



4412.29 Bicchiere

Tumbler
Verre
Becher

∅ 65 ↑ 105



4413.29 Portasapone

Soap dish

Porte-savon

Seifenablage

∅ 110 ↑ 30



3901 Portasapone

Soap dish

Porte-savon

Seifenschale

∅ 115 ↑ 24



4414.29 Bicchiere

Tumbler

Verre

Becher

∅ 72 ↑ 100



4072.80 Bicchiere e dosasapone in vetro

Tumbler and soap dispenser

Verre et distributeur savon liquide

Becher und Seifenspender

Dosasapone ∅ 70 ↑ 182

Soap dispenser

Distributeur savon liquide

Seifenspender

Bicchiere ∅ 70 ↑ 130

Tumbler

Verre

Becher



44281.29 Contenitore portasalviette

Hand towels box

Réceptacle porte serviettes lave-mains

Behälter für Handtücher

→ 200 ↑ 60 ↗ 150



44018 Dosasapone verniciato e inox

Painted soap dispenser

Distributeur savon liquide verni et inox

Seifenspender lackiert

∅ 80 ↑ 160



55003 Bicchiere

Tumbler

Verre

Becher

∅ 75 ↑ 105



.09 .80 .81



.09 .80 .81

55006 Dosasapone 200 ml

Soap dispenser 200 ml

Distributeur savon liquide 200 ml

Seifenspender 200 ml

∅ 75 ↑ 185

53020 Bicchiere

Tumbler

Verre

Becher

∅ 80 ↑ 105



.09 .29 .81

44070.29 Ghiera per accessori serie 'NAPIE' da appoggio

Ring for tabletop 'NAPIE' accessories

Anneau pour accessoires 'NAPIE' d'appui

Ring für Accessories am Boden Serie 'NAPIE'

∅ 70 ↑ 25



55004 Portasapone

Soap dish

Porte-savon

Seifenschale

∅ 120 ↑ 30



.09 .80 .81

53022 Dosasapone 300 ml

Soap dispenser 300 ml

Distributeur savon liquide 300 ml

Seifenspender 300 ml

∅ 80 ↑ 165



.09 .29 .81



5200

Griglietta in silicone antiscivolo per Art. 55004 (20 pezzi assortiti in 4 colori)

20 grip grids for soap dish 55004

20 grilles pour porte savon 55004

20 Einlagen für Seifenschale 55004

∅ 50 ↑ 18



53021 Portasapone

Soap dish

Porte-savon

Seifenschale

∅ 120 ↑ 45



.09 .29 .81

44019.29 Bidoncino da tavolo tondo inox

Round table paper bin

Petite boîte ronde à ordures pour la table

Tischabfallbehälter rund

∅ 120 ↑ 163



44020.29 Bidoncino da tavolo quadrato inox

Square table paper bin

Petite boîte carrée à ordures pour la table

Tischabfallbehälter quadratisch

→ 118 ↑ 157 ↗ 118



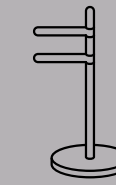

Collezione Piantane
Stands Collection

Collection Ensembles d'Accessoires sur Pied
Kollektion Wc Kombination und Handtuchständer

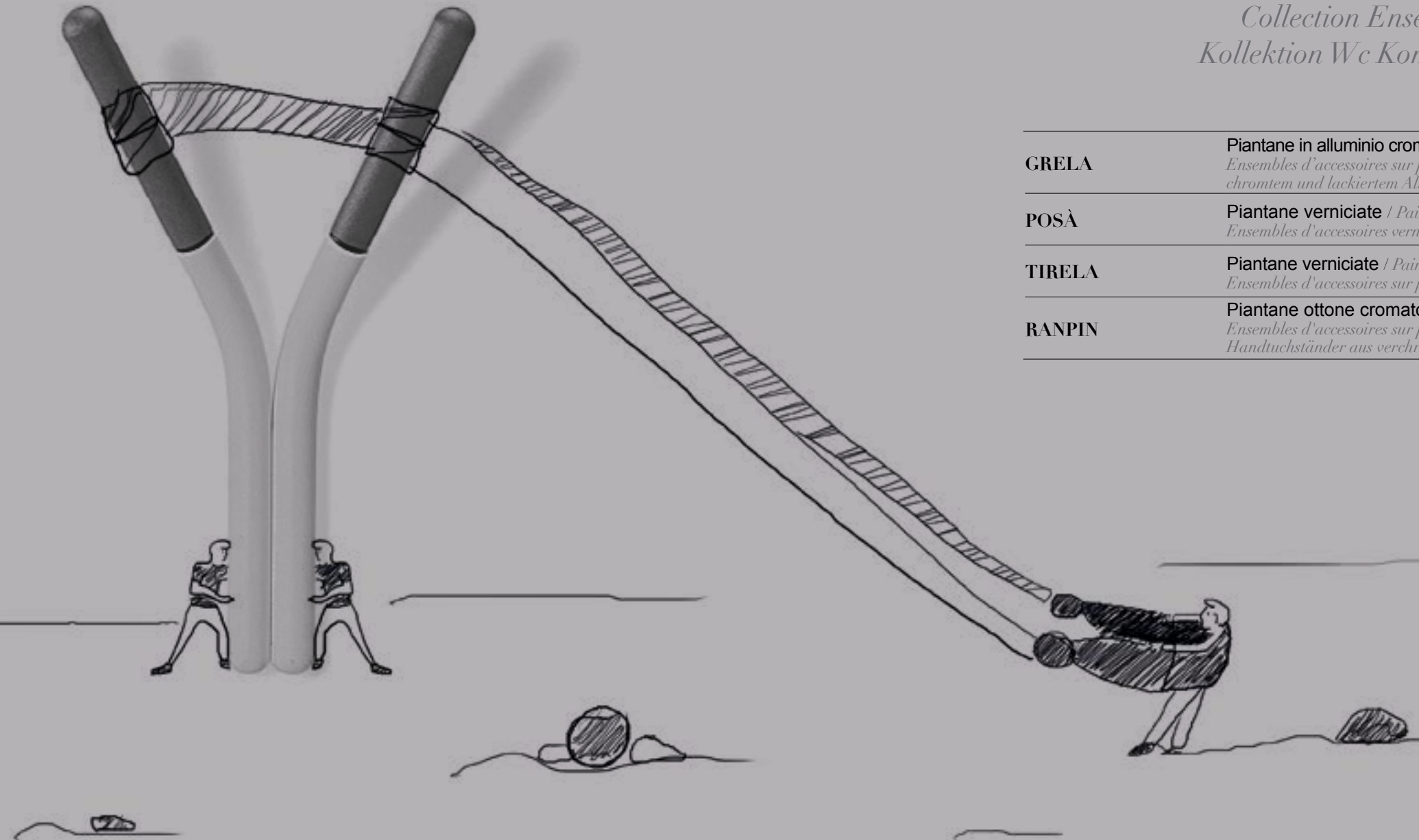

GRELA	Piantane in alluminio cromato e verniciate / <i>Chromed and painted aluminium stands / Ensembles d'accessoires sur pied en aluminium chromé et verni / Handtuchständer aus verchromtem und lackiertem Aluminium</i>	181
POSÀ	Piantane verniciate / <i>Painted stands / Ensembles d'accessoires vernis / Lackierte Handtuchständerries</i>	185
TIRELA	Piantane verniciate / <i>Painted stands / Ensembles d'accessoires sur pied vernis / Lackierte Handtuchständer</i>	187
RANPIN	Piantane ottone cromato / <i>Chromed brass stands / Ensembles d'accessoires sur pied laiton chromé / Handtuchständer aus verchromtem Messing</i>	189



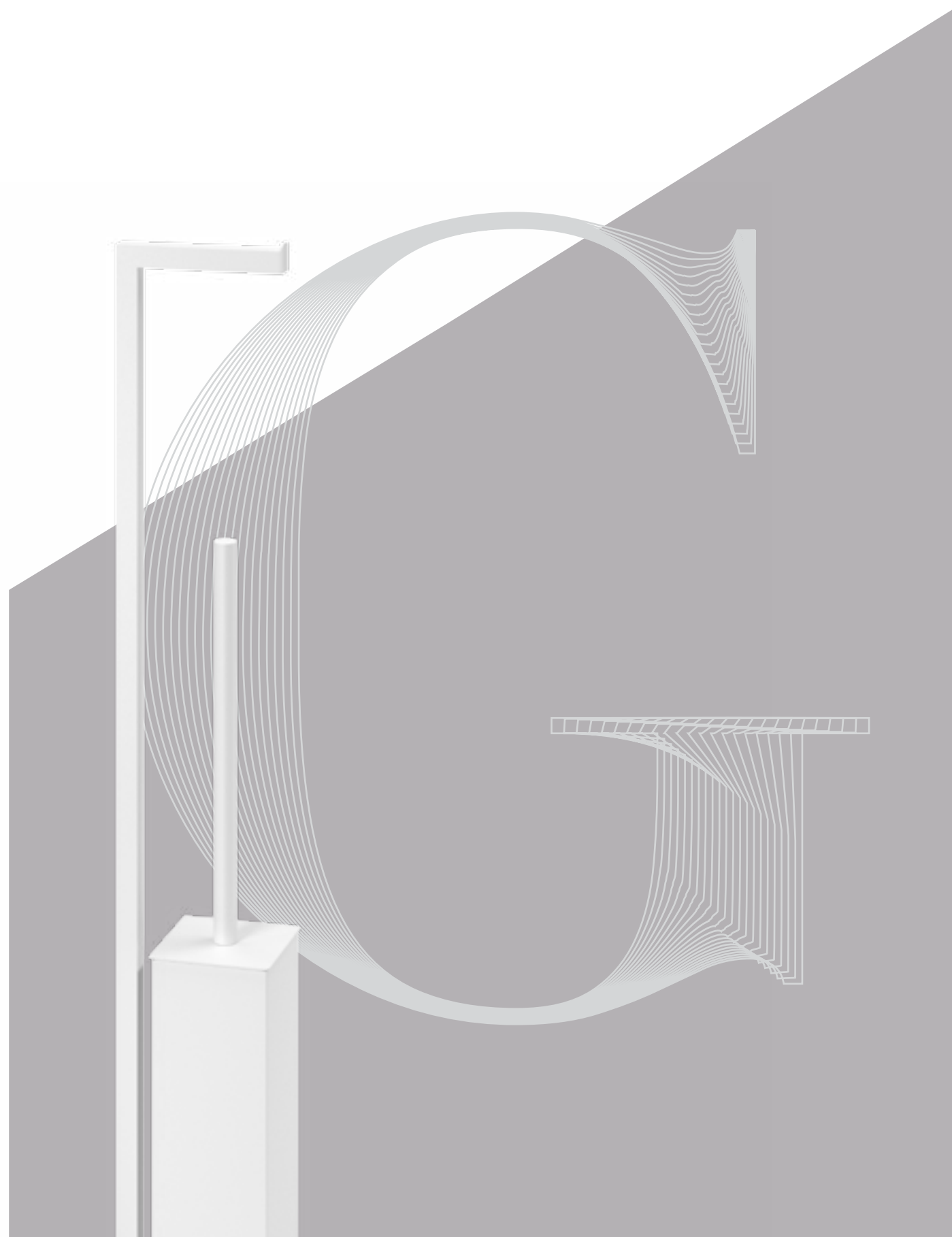

G raticola. (Gre-lah).
Le piantane della collezione
Grela sono formate da
blocchi volumetrici ampi e di grande
impatto visivo, oltre ad essere leggere
e funzionali.

EN~ *Rack. The stands of Grela collection are formed by large volumetric blocks with great visual impact, in addition to being read and functional.*

FR~ *(Gre-lah) Grille. Ces produits de la collection Grela sont formés par de gros blocs volumétrique et de fort impact visuel, en plus d'être légers et fonctionnels.*

DE~ *(Gre-lah) Kühlregal. Die Pfosten der Grela Sammlung sind durch große volumetrische Blöcke und auch optisch sehr ansprechend, und zudem leicht und funktional.*



5116



5117



5118



5116 Piantana con portarotolo e portascopino

Toilet paper and brush holder stand

Porte-rouleau sur pied avec porte-balais

Kombi-Bürstengarnitur mit Papierhalter und WC-Bürste

∅ 193 ↑ 752



.09



.29



.33

5117 Piantana portasalviette

Towel holder stand

Porte-serviettes sur pied

Handtuchständer

→ 350 ↑ 850 ↗ 170



5118 Scaletta appoggio a muro portasalviette

Wall towel holder ladder

Echelle porte-serviettes murale

Handtuchständer mit Anlehnung am Wand

→ 450 ↑ 1750 ↗ 300





Appoggiate. Collezione composta da una scaletta a pioli e un appendino, dalle linee morbide in metallo verniciato a polveri. Questa serie è stata disegnata da Nicolò Stivanello per il Lineabeta LAB 2012.

EN~ *Leaned. Collection composed by a ladder and a hook with a soft design, made with dust painted metal. This collection was designed by Nicolò Stivanello for Lineabeta LAB 2012.*

FR~ *Collection composée d'une échelle et d'un crochet, aux lignes douces en métal verni à la poudre. Cette série a été conçue par Nicolò Stivanello pour le Lineabeta LAB 2012.*

DE~ *Sammlung von Kleiderbügel, bestehend aus einer Leiter und einem Haken, mit weichen Linien in pulverbeschichtetem Metall. Diese Serie wurde von Nicolò Stivanello für LAB 2012 Lineabeta entworfen.*



5132 Appendino

Bathrobe hanger

Patère

Hacken

→ 170 ↑ 290 ↗ 80



5130 Scaletta portasalviette

Towel holder

Echelle porte-serviettes

Handtuchständer

→ 600 ↑ 1800 ↗ 220



TIRELA

Tirela



Filo che collega due pali.
Piantana porta asciugamani
o porta riviste in metallo
verniciato a polveri e tondino
saldato in modo da evidenziare la
lavorazione grezza. Disegnata da
Studio Zaven nel 2012.

EN~ Wire that connects two poles. Towel or magazines holder floor stand made of dust painted metal and welded rebar to highlight the unrefined craftsmanship. Designed by Studio Zaven in 2012.

FR~ Porte-serviettes ou porte-magazines sur pied en métal vernis à poudre. Les soudures bien visibles sont une caractéristique de cet article, conçu par Studio Zaven LAB 2012.

DE~ Handtuch-Zeitschriftenständer aus lackiertem Metall und mit geschweißtem Rundeisen, um die Rohverarbeitung hervorzuheben. Gezeichnet von Studio Zaven in 2012.



5110 Piantana portasalviette

Towel stand

Porte-serviettes sur pied

Handtuchständer

→ 610 ↑ 900 ↗ 310





Rampino. Sistema di piantane polifunzionali in ottone cromato o acciaio in diverse altezze, attrezzabili in coordinato con la collezione 'BAKETO'.

EN~ *Hook. Fully featured chromed brass or stainless steel floor stands with different heights and customizable with 'BAKETO' collection.*

FR~ *Ensemble multifonctions de accessoires en laiton chromé ou acier, dans plusieurs hauteurs, à équiper avec les articles de la série 'BAKETO'.*

DE~ *Sammlung von Handtuchständer aus verchromtem Messing oder Edelstahl in verschiedenen Größe, kombinierbar mit Zubehör der Serie 'BAKETO'.*



5113



5114



5115



5120



5124



5126



51191



51193



51192



51194



51195



51239



51259



51239 + 52241
55006 - 5229 - 5226

5113.29 Piantana portarotolo e portascopino

Toilet paper and brush holder stand

Porte-rouleau sur pied avec porte-balais

Kombi-Bürstengarnitur mit Papierhalter und WC-Bürste

→ **200** ↑ **575** ↗ **180**



5115.29 Piantana portasalvietta

Towel holder stand

Porte-serviettes sur pied

Handtuchständer

→ **300** ↑ **875** ↗ **160**

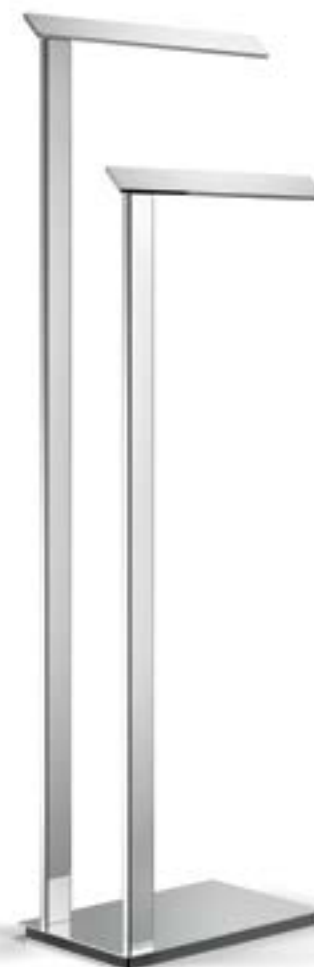

5114.29 Piantana portarotolo, portascopino e portasalvietta

Towel, paper and brush holder stand

Porte-rouleau sur pied avec porte-balais et p.serviette

Kombi-Bürstengarnitur mit Papierhalter, WC-Bürste und Handtuchhalter

→ **360** ↑ **675** ↗ **130**



5120.29 Piantana con 3 portasalvietta

Towel-stand, 3 arms

Porte-serviettes 3 barres sur pied

Handtuchständer mit 3 Arme

∅ **275** ↑ **900** ↗ **450**



5124.29 Piantana con portarotolo e portascopino

Toilet paper and brush holder stand

Porte-rouleau et balai sur pied

Kombi-Bürstengarnitur mit Papierhalter und WC-Bürste

∅ 193 ↑ 660 ↗ 260



51191.29 Piantana con 3 portasalvietta

Towel-stand, 3 arms

Porte-serviettes sur pied 3 barres

Handtuchständer mit 3 Arme

→ 230 ↑ 910 ↗ 430



51193.29 Piantana con portarotolo e portascopino

Toilet paper and brush holder stand

Porte-rouleau et balai sur pied

Kombi-Bürstengarnitur mit Papierhalter und WC-Bürste

→ 170 ↑ 660 ↗ 260

5126.29 Piantana appendiabiti

Hooks-stand

Porte manteaux sur pied

Kleiderständer

∅ 275 ↑ 1800

Combinabile con serie 'BAKETO'

Matching with 'BAKETO' range

À équiper avec 'BAKETO' collection

Verwendbar mit 'BAKETO' Serie



51192.29 Piantana alta attrezzabile

Accessories stand, tall

Porte-accessoires haut sur pied (à équiper)

Ständer zu Kombinieren (groß)

→ 230 ↑ 910 ↗ 230

Combinabile con serie 'BAKETO'

Matching with 'BAKETO' range

À équiper avec 'BAKETO' collection

Verwendbar mit 'BAKETO' Serie



51194.29 Piantana bassa attrezzabile*Accessories stand, low**Porte-accessoires bas sur pied (à équiper)**Ständer zu Kombinieren (klein)*

→ 170 ↑ 665 ↗ 170

Combinabile con serie 'BAKETO'*Matching with 'BAKETO' range**À équiper avec 'BAKETO' collection**Verwendbar mit 'BAKETO' Serie***51195.29 Piantana appendiabiti***Hooks-stand**Porte manteaux sur pied**Kleiderständer*

→ 230 ↑ 1800 ↗ 230

Combinabile con serie 'BAKETO'*Matching with 'BAKETO' range**À équiper avec 'BAKETO' collection**Verwendbar mit 'BAKETO' Serie***51239.29 Piantana alta attrezzabile***Accessories stand, tall**Porte-accessoires haut sur pied (à équiper)**Ständer zu kombinieren (groß)*

∅ 275 ↑ 910

Combinabile con serie 'BAKETO'*Matching with 'BAKETO' range**À équiper avec 'BAKETO' collection**Verwendbar mit 'BAKETO' Serie***51259.29 Piantana alta attrezzabile***Accessories stand, low**Porte-accessoires bas sur pied (à équiper)**Ständer zu kombinieren (klein)*

∅ 193 ↑ 660

Combinabile con serie 'BAKETO'*Matching with 'BAKETO' range**À équiper avec 'BAKETO' collection**Verwendbar mit 'BAKETO' Serie*

Esempio di piantana attrezzata

Example of accessoried stand

*Porte-accessoires sur pied équipé
(exemple)*

Beispiel für Ständer mit Accessoires

51239 Piantana alta attrezzabile

Accessories stand, tall

Porte-accessoires haut sur pied (à équiper)

Ständer zu Kombinieren (groß)

52241 Supporto per barra

Single holder for rail

Support pour colonne

Halter für Stange

55006 Dosasapone 200 ml

Soap dispenser 200 ml

Distributeur savon liquide 200 ml

Seifenspendler 200 ml

5229 Portasalvietta per barra

Towel rail for rail

Porte-serviettes pour colonne

Handtuchhalter für Stange

5226 Portarotolo per barra

Toilet paper holder for rail

Porte-rouleau pour colonne

Toilettenpapierhalter für Stange



Base tonda
Circular base
Base ronde
Runde Bodenplatte



Base quadrata
Square base
Base carrée
Quadratische Bodenplatte



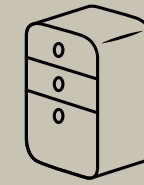

Collezione Contenitori & Mobili
Cabinets and Furniture Collection
Collection Armoires et Meubles
Kollektion Schränke



GRELA	Mobili in legno e alluminio cromato e verniciato / <i>Wood and chromed or painted aluminum furniture / Meubles en bois et aluminium chromé et verni / Schränke aus Holz und verchromtem und lackiertem Aluminium</i>	201
CANAVERA	Mobili in bambù / Bamboo furniture / <i>Meubles en bambou / Schränke aus Bamboo</i>	221
CIACOLE	Contenitori in alluminio verniciato / Painted aluminium cabinets / <i>Armoires en aluminium verni / Schränke aus lackiertem Aluminium</i>	233
PIKÀ	Contenitori in acciaio inox / Stainless steel cabinets / <i>Armoires en acier inox / Schränke aus Edelstahl</i>	239
RUNNER	Mobili con ruote in acciaio inox e verniciati / Stainless steel and painted cabinets <i>on wheels / Meubles sur roulettes en acier inox et vernis /</i> <i>Rollschränke aus Edelstahl und lackiert</i>	245

GRELA



Graticola. (Gre-lah).
 Collezione di mobili
 contenitori in metallo
 verniciato o cromato e cassetti in
 nobilitato con finiture noce e nero
 opaco.

EN~ *Rack. Collection of furniture in painted or chromed metal frames, drawers made of MDF in walnut or black matt finishing.*

FR~ *Collection de meubles conteneurs en métal verni ou chromé et tiroirs en MDF avec finition en noyer canaletto et Phoenix noir.*

DE~ *Sammlung von Behältern aus lackiertem Metall oder Chrom und Schubladen in MDF mit Nussbaum Oberflächen und Phoenix Schwarz.*

SMALL



8220
8221
53570

MEDIUM



8240
8241
53571-535711
8242

LARGE



8260
8261
53572-535721
8262

TASCA / Pouch Poche / Tasche



7218



53993.29



53972.29



53927.29



51701



51702



51703



51705



51706



51708



51709



5116



5117



5118



.03



.18

8220

Base sospesa Small

Small wall door unit

Meuble suspendu Small

Wuandschrank Small

→ 430 ↑ 435 ↗ 280



.09

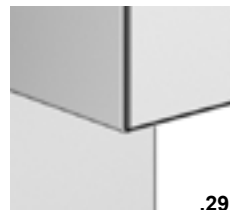

.29

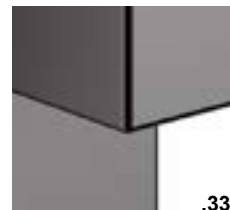

.33

8221

Telaio per base sospesa Small

Wireframe for Small door unit

Structure pour meuble suspendu Small

Halterung für Schrank Small

→ 460 ↑ 450 ↗ 280



53570

Lavamani con foro rubinetto per base sospesa Small mineralmarmo

Washbasin with mixer hole for Small door unit

Lavabo avec perçage de robinetterie pour meuble Small

Waschbecken mit Armaturloch für Schrank Small

→ 460 ↑ 135 ↗ 280





8240 **Base sospesa Medium**
Medium wall door drawer unit
Meuble suspendu Medium
Wandschrank Medium
 → 590 ↑ 435 ↗ 460

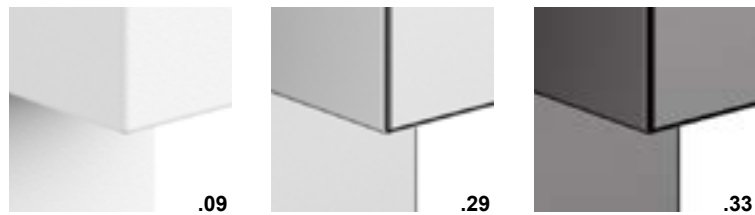

8241 **Telaio per base sospesa Medium**
Wireframe for Medium drawer unit
Structure pour meuble suspendu Medium
Halterung für Schrank Medium
 → 705 ↑ 450 ↗ 460

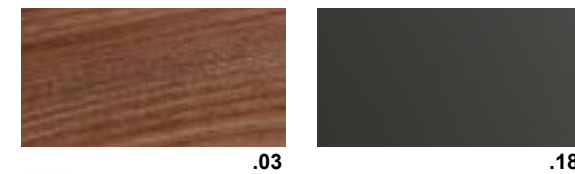

8242 **Top base sospesa Medium**
Top for Medium drawer unit
Plateau pour meuble Medium
Platte für Schrank Medium
 → 605 ↑ 18 ↗ 460



53571 **Lavabo per base sospesa Medium con foro rubinetto in mineralmarmo**
Washbasin with mixer hole for Medium drawer
Lavabo avec perçage de robinetterie pour meuble Medium
Washbecken mit Armaturloch für Schrank Medium
 → 605 ↑ 160 ↗ 460

535711 **Senza foro rubinetto in mineralmarmo**
Without mixer hole
Sans perçage de robinetterie
Ohne Armaturloch
 → 605 ↑ 160 ↗ 460



7218 **Tasca in tessuto con clip per attacco a telaio 'GRELA'**
Pouch with clip for 'GRELA' wireframe
Poche avec clip pour 'GRELA' structure
Tasche mit Klipp für Halterung 'GRELA'
 → 278 ↑ 300



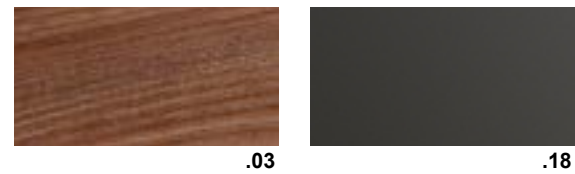

8260 Base sospesa Large
Large drawer unit
Meuble suspendu Large
Schrank Large
 → 890 ↑ 435 ↗ 460

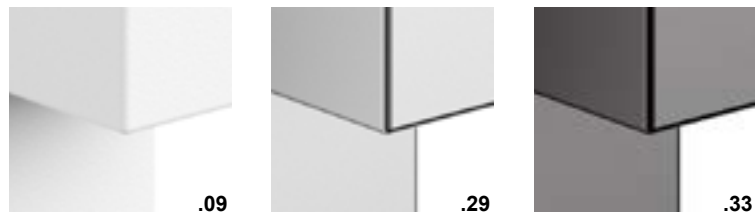

8261 Telaio per base sospesa Large
Wireframe for Large drawer unit
Structure pour meuble suspendu Large
Halterung für Schrank Large
 → 1000 ↑ 450 ↗ 460

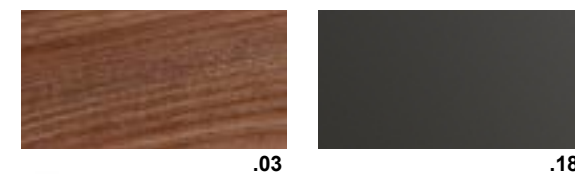

8262 Top base sospesa Large
Top for Large drawer unit
Plateau pour meuble Large
Platte für Schrank Large
 → 905 ↑ 18 ↗ 460



53572 Lavabo per base sospesa Large con foro rubinetto in mineralmarmo
Washbasin with mixer hole for Large drawer
Lavabo avec perçage de robinetterie pour meuble Large
Washbecken mit Armaturloch für Schrank Large
 → 905 ↑ 160 ↗ 460



535721 Senza foro rubinetto in mineralmarmo
Without mixer hole
Sans perçage de robinetterie
Ohne Armaturloch
 → 905 ↑ 160 ↗ 460

7218 Tasca in tessuto con clip per attacco a telaio 'GRELA'
Pouch with clip for 'GRELA' wireframe
Poche avec clip pour 'GRELA' structure
Tasche mit Klipp für Halterung 'GRELA'
 → 278 ↑ 300





7218

Tasca in tessuto con clip per attacco a telaio 'GRELA'

Pouch with clip for 'GRELA' wireframe

Poche avec clip pour 'GRELA' structure

Tasche mit Klipp für Halterung 'GRELA'

→ 278 ↑ 300



53927.29 Sifone salvaspazio, 1"-1/4 mm

Space saving siphon, 1" 1/4 mm

Siphon gain de place, pouces 1" 1/4 mm

Sifon 1" 1/4 platzsparend



→ 32 ↑ max 380 ↗ max 350



53993.29 Piletta automatica click senza troppopieno, max 30 mm

Automatic waste water drain without overflow, max 30 mm

Bonde automatique click sans trop-plein max 30 mm

Druck - Ablaufgarnitur ohne Überlauf max 30 mm

∅ 42 ↑ max 30



53972.29 Piletta scarico libero 1"-1/4 mm, max 50 mm

Free waste water drain 1" 1/4 mm, max 50 mm

Bonde à écoulement libre 1" 1/4, max 50 mm

Freie Ablaufgarnitur 1" 1/4, max 50 mm

∅ 42 ↑ max 50



51701 Portarotolo

Toilet paper holder

Porte-rouleau

Toilettenpapierhalter

→ 130 ↑ 15 ↗ 108



51703 Appendino a G

G shaped hook

Patère G

Hacken G

→ 15 ↑ 70 ↗ 85



.09

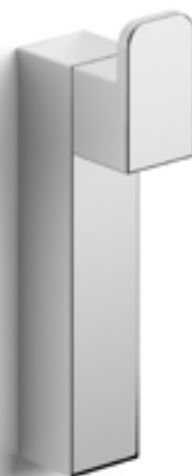

.29



.33

51702 Appendino a L

L shaped hook

Patère L

Hacken L

→ 15 ↑ 80 ↗ 30

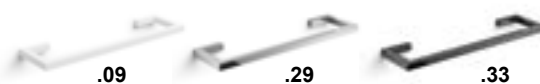

51705 Portasalvietta 400 mm

Towel rail 400 mm

Porte-serviettes 400 mm

Handtuchhalter 400 mm

→ 400 ↑ 15 ↗ 108



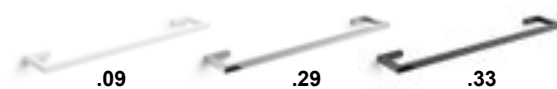

51706 Portasalvietta 600 mm

Towel rail 600 mm
Porte-serviettes 600 mm
Handtuchhalter 600 mm

→ 600 ↑ 15 ↗ 108



51708 Porta accessori 400 mm

Accessories bar 400 mm
Support 400 mm pour accessoires
Halter für Zubehör 400 mm

→ 400 ↑ 15 ↗ 108



51709 Porta accessori 600 mm

Accessories bar 600 mm
Support 600 mm pour accessoires
Halter für zubehöre 600 mm

→ 600 ↑ 15 ↗ 108



5146 Portaspazzolini con coperchio verniciato

Toothbrush holder with painted lid
Porte-brosses à dents avec couvercle vernis
Zahnputzbecher mit lackiertem Deckel

→ 85 ↑ 105 ↗ 85



5147 Portasapone con coperchio verniciato

Soap dish with painted lid
Porte-savon avec couvercle vernis
Seifenschale mit lackiertem Deckel

→ 130 ↑ 60 ↗ 85



5152 Dosasapone con coperchio verniciato

Soap dispenser with painted lid
Distributeur savon liquide avec couvercle vernis

Seifenspender mit lackiertem Deckel

→ 85 ↑ 150 ↗ 90



5148 Scatola portaoggetti con coperchio verniciato

Box with painted lid
Boîte p.objets avec couvercle vernis
Schale mit lackiertem Deckel

→ 205 ↑ 60 ↗ 85





5116 Piantana con portarotolo e portascopino

Toilet paper and brush holder stand

Porte-rouleau sur pied avec porte-balais

Kombi-Bürstengarnitur mit Papierhalter und WC-Bürste

∅ 193 ↑ 752



5118 Scaletta appoggio a muro portasalviette

Wall towel holder ladder

Echelle porte-serviettes murale

Handtuchständer mit Anlehnung am Wand

→ 450 ↑ 1750 ↗ 300

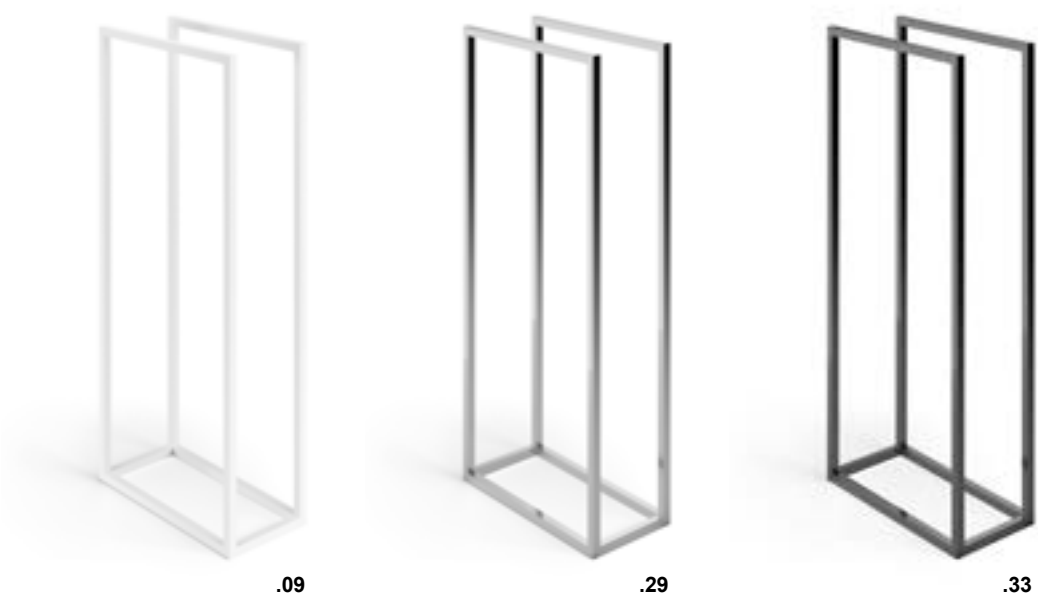

5117 Piantana portasalviette

Towel holder stand

Porte-serviettes sur pied

Handtuchständer

→ 350 ↑ 850 ↗ 170





Canna di bambù. Mobili, piani e basi d'appoggio in 100% bambù massello, verniciati ad acqua, per coniugare perfettamente qualità e rispetto dell'ambiente, impeccabile combinazione eco-friendly. Disponibili con top naturale o in mattstone.

EN~ *Bamboo stick. Furniture, tops and base made of 100% solid bamboo wood. They're water-base varnished to ensure quality and eco-friendly. Available with natural wood top or mattstone top.*

FR~ *Meubles, plans et bases de support 100 % bambou massif, vernis à l'eau, pour associer parfaitement qualité et respect de l'environnement, parfaite combinaison eco-friendly; Disponibles avec top naturel ou en pierre composite.*

DE~ *Möbel, Fußböden und Unterstützungsbasen in 100% festen Bambus, mit Wasserfabre lackiert, um Qualität und Respekt für die Umwelt perfekt zu kombinieren, eine einwandfreie Kombination, die auch umweltfreundlich ist. Erhältlich mit natürlichem Top oder in mattstone.*



81107.03 Supporto per lavabo

Wash-table unit

Meuble pour lavabo

Waschtisch

→ 700 ↑ 760 ↗ 460



81110.03 Supporto per lavabo

Wash-table unit

Meuble pour lavabo

Waschtisch

→ 1000 ↑ 760 ↗ 460



81113.03 Supporto per lavabo

Wash-table unit

Meuble pour lavabo

Waschtisch

→ 1300 ↑ 760 ↗ 460



81119.03 Sgabello

Stool
Tabouret
Hocker

→ 400 ↑ 450 ↗ 290



81120.03 Panca

Bench
Banc
Bank

→ 1100 ↑ 450 ↗ 360



81121.03 Base 1 cassetto

One drawer unit
Meuble 1 tiroir
Schrank 1 Schublade

→ 400 ↑ 382 ↗ 460



81122.03 Base 2 cassetti

2 drawers unit
Meuble 2 tiroirs
Schrank 2 Schublade

→ 400 ↑ 382 ↗ 460



81123.03 Base 2 cassetti

2 drawers unit
Meuble 2 tiroirs
Schrank 2 Schublade

→ 400 ↑ 564 ↗ 460



81130.03 Pensile reversibile con ripiani in vetro

Reversible cabinet with glass shelves
Armoire avec tablettes en verre, reversible

Schrank mit inneren Glasablagen
Wechselseitige Montage

→ 300 ↑ 1600 ↗ 200





Base supporto lavabo, 1 cassetto

1 drawer unit for washbasin
Meuble pour lavabo avec 1 tiroir
Schrank 1 Schublade

81167.03 → 700 ↑ 200 ↗ 460
81169.03 → 900 ↑ 200 ↗ 460

Abbinabile con sifone Art. 53921

Matching with siphon Art. 53921
Compatible avec siphon Art. 53921
Verwendbar mit Siphon Art. 53921



TOP in bamboo

Top bamboo
Plateau bamboo
Platte bamboo

811219.03 → 460 ↑ 18 ↗ 400
811679.03 → 700 ↑ 18 ↗ 460
811699.03 → 900 ↑ 18 ↗ 460



811600.26 Top su disegno lunghezza massima 1800 x 460 mm

Bespoke top, maximum length 1800 x 460 mm
Plan sur mesure longueur maximum 1800 x 460 mm
Platte nach Maße maximale Länge 1800 x 460 mm



81129.29 Set 4 piedini per basi

4 feet set
4 petit pieds
Set 4 Füße

→ 40 ↑ 100 ↗ 62



81140.03 Specchio con cornice verticale o orizzontale

Mirror vertical or horizontal with frame
Miroir vertical ou horizontal, avec cadre
Spiegel mit Rahmen, senkrecht oder waagrecht

→ 400 ↑ 900 ↗ 42



81141.03 Specchio contenitore reversibile con ripiani in vetro

Reversible ontainer mirror with glass shelves
Armoire de toilette avec Miroir, reversible
Spiegelbehälter mit Glasablage Wechselseitige Montage

→ 400 ↑ 800 ↗ 150







Chiacchiere. Una linea determinata dall'idea di bagno flessibile, comodo e funzionale. Sistema di contenitori a colonna, aperti o con battente a specchio, da fissare a parete o girevoli, realizzati in alluminio e mattstone. Disponibili anche particolari lavorazioni fresate a secco sul mattstone per un effetto decorativo e prezioso.

EN~ *Small talks. A collection that follows the concept of a flexible, comfortable and functional bathroom. Column containers, open or with mirrored shutter, to be wall hanged or turnable, made of mattstone or aluminium. Available also with particular machine-milled finishings to obtain a precious and decorative effect.*

FR~ *Une ligne déterminée par l'idée de salle de bain flexible, confortable et fonctionnelle. Système de conteneurs en colonne, ouverts ou avec battants à miroir, à fixer au mur ou pivotant, fabriqués en aluminium et pierre composite. Également disponibles, un travail de fraisage à sec particulier sur pierre composite pour un effet décoratif et précieux.*

DE~ *Eine besondere Linie auf Basis der Idee eines flexiblen Bades, komfortabel und funktional. Ein System aus Spalten-Containern, offenen oder mit Spiegel schwingend, können an der Wand oder schwenkbar befestigt werden, aus Aluminium und mattstone. Auch erhältlich spezielle trocken in mattstone bearbeitet, für einen dekorativen und wertvollen Effekt.*



8040



8058



8050



8054

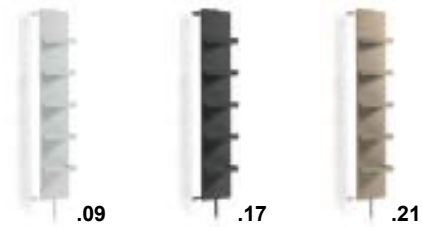

8040 Pensile girevole con specchio verniciato

Swivel cabinet with mirror
Armoire pivotant avec miroir
Drehbarer Schrank mit Spiegel

→ 280 ↑ 1790 ↗ 370

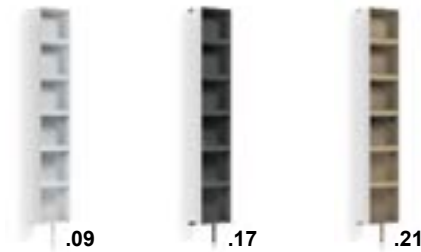

8058 Pensile girevole con specchio e fianchi in mattstone

Swivel cabinet with mirror, mattstone panelled sides
Armoire pivotant avec miroir et côtés mattstone
Drehbarer Schrank mit Spiegel und Seite aus Mattstone

→ 265 ↑ 1760 ↗ 235



8050 Pensile con anta a specchio e fianchi in mattstone

Cabinet with mirror door, mattstone panelled sides
Armoire avec porte miroir et côtés mattstone
Schrank mit Spiegeltür und Seite aus Mattstone

→ 265 ↑ 800 ↗ 165

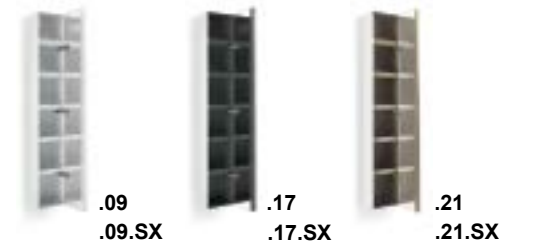

8054 Pensile con anta a specchio e fianchi in mattstone

Cabinet with mirror door, mattstone panelled sides
Armoire avec porte miroir et côtés mattstone
Schrank mit Spiegeltür und Seite aus Mattstone

→ 265 ↑ 1590 ↗ 165

Disponibile anche con apertura SX (-SX)

Available also with left opening (.L)
Disponibile avec ouverture gauche (.L)
Verfügbar also mit Linksanschlag (.L)





8040 CIACOLE

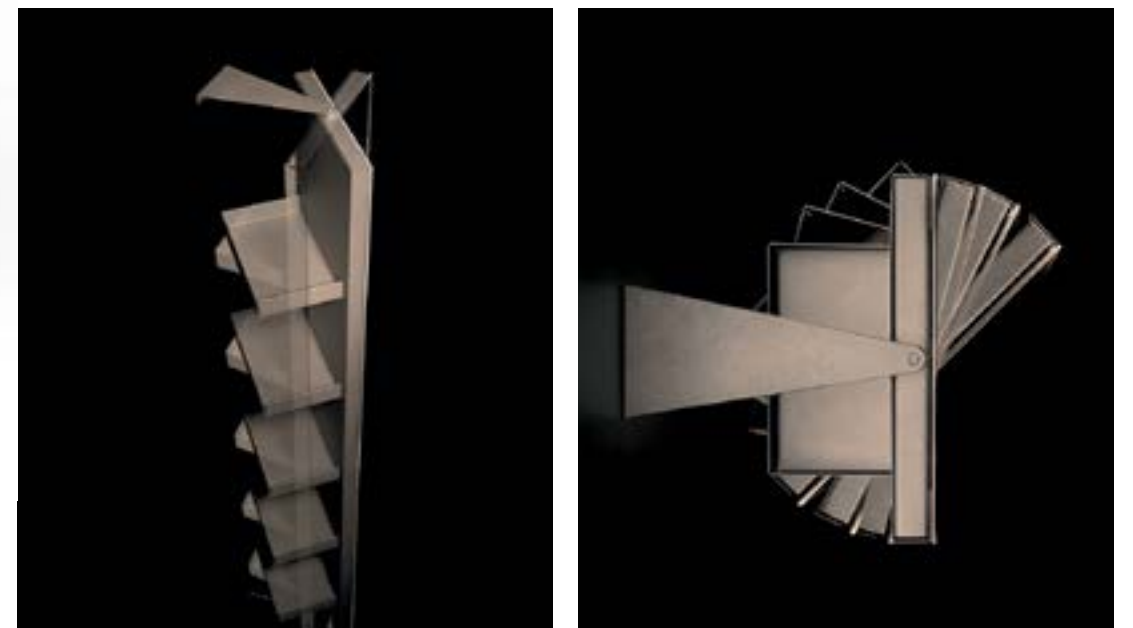



Appeso. Serie di pensili a muro e rotanti dotati di specchio a filo lucido garantito 5 anni o ante in vetro satinato, dal design funzionale, realizzati in acciaio inox lucido con ripiani interni in vetro temperato satinato.

EN~ *Hung. Wall and rotating shelves collection with 5 years guaranteed silvering bevelled mirror o satinad glass shutters. Designed with a modern feel and made of polished stainless steel with tempered satinad glass shelving.*

FR~ *Série d'armoires murales rotatives dotées de miroirs à bord poli, garanti 5 ans ou devant en verre givré, au design fonctionnel, fabriquées en acier inox brillant avec étagères internes en verre trempé givré.*

DE~ *Reihe für die Wand mit polierter Kante und Spiegel, garantiert für 5 Jahre oder mattierte Glastüren, im funktionellen Design, aus poliertem Edelstahl mit Regalen in mattiert gehärtetem Glas.*



51502



51504



51505



51506



51511



51512



51502.29.79 Pensile con specchio

Cabinet with mirror
Armoire avec miroir
Schrank mit Spiegeltür

→ 280 ↑ 830 ↗ 155



51504.29.79 Pensile con specchio

Cabinet with mirror
Armoire avec miroir
Schrank mit Spiegeltür

→ 280 ↑ 1630 ↗ 155



51505.29 Pensile girevole con specchio

Swivel cabinet with mirror
Armoire colonne pivotante avec miroir
Drehbarer Schrank mit Spiegel

→ 160 ↑ 1830 ↗ 235



51506.29 Pensile girevole con specchio

Swivel cabinet with mirror
Armoire colonne pivotante avec miroir
Drehbarer Schrank mit Spiegel

→ 250 ↑ 1830 ↗ 265





51511.29 Pensile reversibile con specchio

Reversible cabinet with mirror

Armoire avec miroir, reversible

Wechselseitiger Schrank mit Spiegeltür

→ 450 ↑ 450 ↗ 155



51512.29 Pensile reversibile con specchio

Reversible cabinet with mirror

Armoire avec miroir, reversible

Wechselseitiger Schrank mit Spiegeltür

∅ 590 ↗ 160



RUNNER

Linea di mobili contenitori dallo stile architettonico, rigoroso e solido, realizzati in inox lucido satinato e verniciato. Sono dotati di ruote bloccabili, per agevolarne lo spostamento ed aumentarne la funzionalità. La linea presenta modelli con cassetti, ante e mensole interne in cristallo trasparente. Perfetti per il bagno, ma perfettamente a loro agio in qualsiasi ambiente della casa e dell'ufficio.

EN~ *Container cabinets collection with an architectonic and rigorous style. Made of solid polished inox and braked wheels to ease movements and functionality. This line presents models with drawers, shutters and transparent crystal shelves. Perfect for the bath room but easily placeable in every part of the house.*

FR~ *Ligne de meubles conteneurs au style architectural, rigoureux et solide, fabriqués en inox brillant et dotés de roues verrouillables, pour faciliter son déplacement et augmenter ses fonctionnalités. La ligne présente des modèles avec tiroirs, portes et étagères internes en cristal transparent. Parfaits pour la salle de bain, mais parfaitement intégrés dans toute pièce de la maison et du bureau.*

DE~ *Eine Linie von Möbelbehältern im architektonischen Stil, strenger und fester, aus poliertem Stahl und mit feststellbaren Rädern, um seine Bewegung zu erleichtern und die Funktionalität zu erhöhen. Die Linie präsentiert Modelle mit Schubladen, Türen und Einlegeböden in transparentem Kristall. Perfekt für das Bad, aber perfekt in jeden Raum im Haus und Büro.*





5430

Base 5 cassetti, con ruote

5 drawers unit on wheels

Meuble sur roulettes avec 5 tiroirs

Rollcontainer 5 Schubladen

→ 350 ↑ 800 ↗ 320



5433.29.29 Base 2 ante, con ruote

2 doors unit on wheels

Meuble sur roulettes avec 2 portes

Rollcontainer 2 Türen

→ 600 ↑ 660 ↗ 320

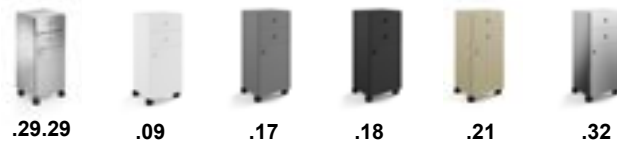

.29.29.L

5431 Base 2 cassetti, 1 ante, con ruote

1 door, 2 drawers unit on wheels

Meuble sur roulettes avec 2 tiroirs et porte

Rollcontainer 2 Schublade 1 Tür

→ 350 ↑ 800 ↗ 320

Disponibile anche con apertura SX (.L)

Available also with left opening (.L)

Disponibile avec ouverture gauche (.L)

Verfügbar also mit Linksanschlag (.L)



5435.29.29 Base 1 cassetto, 1 ante, con ruote

1 door with 1 drawer on wheels

Meuble sur roulettes avec 1 tiroir et porte

Rollcontainer 1 Schublade und 1 Tür

→ 350 ↑ 800 ↗ 320

Disponibile anche con apertura SX (.L)

Available also with left opening (.L)

Disponibile avec ouverture gauche (.L)

Verfügbar also mit Linksanschlag (.L)





5436 Base 3 cassetti, con ruote

3 drawers unit, on wheels

Meuble sur roulettes avec 3 tiroirs

Rollcontainer 3 Schubladen

→ 350 ↑ 510 ↗ 420



5438 Base 2 cassetti, con ruote

2 drawers unit, on wheels

Meuble sur roulettes avec 2 tiroirs

Rollcontainer 2 Schubladen

→ 350 ↑ 510 ↗ 420

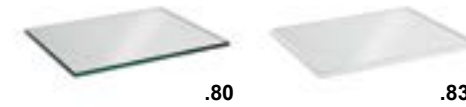

Copribase vetro

Glass TOP

Tablette en verre

Glasplatte

5439 → 350 ↑ 6 ↗ 300

5440 → 400 ↑ 6 ↗ 350





Collezione Specchi & Lampade
Mirrors and Lamps Collection
Collection Miroirs et Lampes
Kollektion Spiegel und Lampen

SPECI	Specchi a muro / Wall mirrors / Miroirs / Wandspiegel	253
MEVEDO	Specchi ingranditori / Magnifying mirrors / Miroirs grossissants / Wand-Vergrößerungspiegel	265
CIARI	Lampade / Lamps / Lampes / Lampen	273





Specchi. Collezione di specchi a parete, dalla forma tonda, ovale, rettangolare o quadrata. Disponibili accoppiati a mensole in cristallo satinato e temperato, a sistema luminoso integrato con accensione e spegnimento touch-screen e regolatore di luce.

EN~ *Mirrors. Collection of round, rectangular, oval or square wall mirrors. Available with satined crystal tempered shelves with integrated LED lightning and touch screen controls.*

FR~ *Collection de miroirs muraux, de forme ronde, ovale, rectangulaire ou carrée. Disponibles couplé à des étagères en cristal satiné et trempé, à système d'éclairage intégré avec allumage et extinction touch-screen.*

DE~ *Wandspiegel-Serie, in runder Form, oval, rechteckig oder quadratisch. Erhältlich gekoppelt als Regale in Satin und gehärtetem Glas, integriertes Beleuchtungssystem mit Zündung und Touch-Screen.*

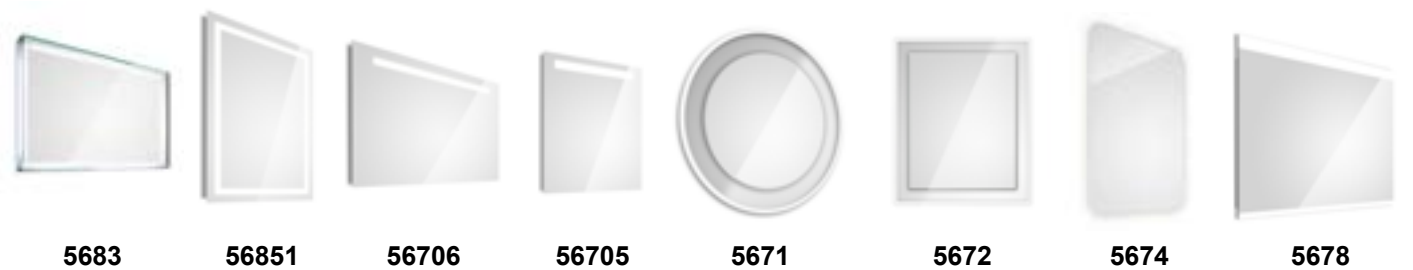



Specchio con struttura inox, con mensola in cristallo satinato e temperato

Mirror with stainless steel frame, with frosted crystal tempered shelf

Miroir avec cadre inox, tablette en verre satiné et trempé

Spiegel mit Ablage satiniertes und gehärtetes Glas

5621.29 → 592 ↑ 826 ↗ 154

5623.29 → 592 ↑ 654,5 ↗ 154



5689 Specchio con luce LED e mensola

Mirror with LED lighting and shelf

Miroir avec étagère et lumière LED

Spiegel mit LED Licht und Ablage

→ 640 ↑ 900 ↗ 150



5631 Specchio con struttura inox

Mirror with stainless steel frame

Miroir avec cadre acier

Spiegel mit Gestell

→ 500 ↑ 700 ↗ 32



**5632 Specchio con struttura inox***Mirror with stainless steel frame**Miroir avec cadre acier**Spiegel mit Gestell*

→ 590 ↗ 32

**5633 Specchio con struttura inox***Mirror with stainless steel frame**Miroir avec cadre acier**Spiegel mit Gestell*

→ 590 ↑ 590 ↗ 32

**5656 Specchio con struttura inox***Mirror with stainless steel frame**Miroir avec cadre acier**Spiegel mit Gestell*

→ 1000 ↑ 440 ↗ 32

**Specchio molato 5 mm***Bevelled 5 mm mirror**Miroir biseauté 5 mm**Spiegel mit Facettenschliff 5 mm***5660** → 600 ↑ 600 ↗ 32**5661** → 800 ↑ 600 ↗ 32**5652 Specchio con struttura inox***Mirror with stainless steel frame**Miroir avec cadre acier**Spiegel mit Gestell*

→ 440 ↑ 1000 ↗ 32

**Specchio con struttura inox***Mirror with stainless steel frame**Miroir avec cadre acier**Spiegel mit Gestell***5653** → 320 ↑ 1000 ↗ 32**5655** → 440 ↑ 1000 ↗ 32**Specchio molato 5 mm***Bevelled 5 mm mirror**Miroir biseauté 5 mm**Spiegel mit Facettenschliff 5 mm***5662** → 1000 ↑ 600 ↗ 32**5663** → 1300 ↑ 600 ↗ 32**Specchio molato 5 mm***Bevelled 5 mm mirror**Miroir biseauté 5 mm**Spiegel mit Facettenschliff 5 mm***5664** → 600 ↑ 800 ↗ 32**5665** → 600 ↑ 1000 ↗ 32

Specchio molato 5 mm, con ingranditore

Bevelled 5 mm mirror included of magnifying mirror

Miroir biseauté 5 mm avec miroir grossissant

Spiegel mit Facettenschliff 5 mm und Vergrößerungsspiegel

5666 → 900 ↑ 440 ↗ 33

5667 → 1100 ↑ 440 ↗ 33



56683 Specchio rotante filo lucido con fissaggio da piano, lato posteriore in acciaio inox

Revolving polished sides mirror with top fixing, back side in stainless steel

Miroir pivotant, fixation sur plan, derrière en acier

Drehbarer Spiegel für Tisch Montage, Rückseite auf Edelstahl

→ 280 ↑ 1074 ↗ 30



Specchio con cornice

Mirror with frame

Miroir avec cadre

Spiegel mit Rahmen

5673 → 325 ↑ 1000 ↗ 35

5676 → 445 ↑ 1000 ↗ 35



56685.29 Specchio filo lucido orientabile

Adjustable mirror

Miroir basculant

Spiegel verstellbar

→ 520 ↑ 800 ↗ 55



56686.29 Specchio filo lucido orientabile

Adjustable mirror

Miroir basculant

Spiegel verstellbar

→ 820 ↑ 500 ↗ 55



5683

Specchio con luce LED, accensione a sensore touch con regolatore di luce*Mirror with LED lighting, touch sensor switch and dimmer**Miroir avec lumière LED, allumage par touch avec régulateur de lumière**Spiegel, Led Licht, Touch Einschalten, Lichtregler*

→ 1000 ↑ 650



56706

Specchio con luce LED, accensione a sensore touch con regolatore di luce*Mirror with LED lighting, touch sensor switch and dimmer**Miroir avec lumière LED, allumage par touch avec régulateur de lumière**Spiegel, Led Licht, Touch Einschalten, Lichtregler*

→ 1000 ↑ 650



56851

Specchio con luce LED, accensione a sensore touch con regolatore di luce*Mirror with LED lighting, touch sensor switch and dimmer**Miroir avec lumière LED, allumage par touch avec régulateur de lumière**Spiegel, Led Licht, Touch Einschalten, Lichtregler*

→ 600 ↑ 800



56705

Specchio con luce LED, accensione a sensore touch con regolatore di luce*Mirror with LED lighting, touch sensor switch and dimmer**Miroir avec lumière LED, allumage par touch avec régulateur de lumière**Spiegel, Led Licht, Touch Einschalten, Lichtregler*

→ 700 ↑ 800





5671 Specchio luce LED cornice illuminata

Framed mirror with LED lighting

Miroir avec lumière LED

Spiegel mit LED beleuchtet Rahmen

Ø 800



IP44 CE

5674 Specchio luce LED

Mirror with LED lighting

Miroir avec lumière LED

Beleuchteter Spiegel mit LED Licht

→ 610 ↑ 810



IP44 CE



5672 Specchio luce LED cornice illuminata

Framed mirror with LED lighting

Miroir avec lumière LED

Spiegel mit LED beleuchtet Rahmen

→ 800 ↑ 900



IP44 CE



5678 Specchio con luce LED, accensione a sensore touch con regolatore di luce

Mirror with LED lighting, touch sensor switch and dimmer

Miroir avec lumière LED, allumage par touch avec régulateur de lumière

Spiegel, Led Licht, Touch Einschalten, Lichtregler

→ 800 ↑ 600



IP44 CE



Mi vedo. Collezione di specchi ingranditori dalla struttura in ottone cromato e ABS e luci a LED.

EN~ *I see myself. Collection of magnifying mirrors with chromed brass and ABS frame and LED lightning.*

FR~ *Collection de miroirs grandissants à la structure chromée et lumières LED.*

DE~ *Spiegel aus verchromtem Messing und LED-Leuchten-Kollektion.*



5588

5591

5592

5593

5594

55943

5595

5596



55963

55851

55852

5581

5583

5584

55864



5588.29 Specchio ingranditore 3X a parete

Wall magnifying 3X mirror

Miroir grossissant 3X mural

Vergrößerungsspiegel Wandmodell 3X

∅ 186 ↑ 220 ↗ 150-450

3x



5591.29 Specchio ingranditore 3X a parete

Wall magnifying 3X mirror

Miroir grossissant 3X mural

Vergrößerungsspiegel Wandmodell 3X

∅ 186 ↗ 293

Disponibile anche / Available also

Disponible en / Verfügbar also

.5X magnifying - .8X magnifying

3x 5x 8x



5594.29 Specchio ingranditore 3X da appoggio

Magnifying table 3X mirror

Miroir grossissant 3X à poser

Vergrößerungsspiegel Standmodell 3X

→ 126 ↑ 326 ↗ 115

3x



5595.29 Specchio ingranditore 3X a parete

Wall magnifying 3X mirror

Miroir grossissant 3X mural

Vergrößerungsspiegel Wandmodell 3X

→ 156 ↑ 206 ↗ 120

3x



5592.29 Specchio ingranditore 3X da appoggio

Magnifying table 3X mirror

Miroir grossissant 3X à poser

Vergrößerungsspiegel Standmodell 3X

∅ 188 ↑ 335

Disponibile anche / Available also

Disponible en / Verfügbar also

.5X magnifying - .8X magnifying

3x 5x 8x



5593.29 Specchio ingranditore 3X da appoggio

Magnifying table 3X mirror

Miroir grossissant 3X à poser

Vergrößerungsspiegel Standmodell 3X

→ 156 ↑ 300 ↗ 115

3x

5594.29 Specchio ingranditore 3X da appoggio

Magnifying table 3X mirror

Miroir grossissant 3X à poser

Vergrößerungsspiegel Standmodell 3X

∅ 186 ↑ 317 ↗ 130

Disponibile anche / Available also

Disponible en / Verfügbar also

.5X magnifying - .8X magnifying

3x 5x 8x





5596.29 Specchio ingranditore 3X a parete

Wall magnifying 3X mirror
 Miroir grossissant 3X mural
 Vergrößerungsspiegel Wandmodell 3X
 → 126 ↑ 230 ↗ 125



55963.29 Specchio ingranditore 3X a parete

Wall magnifying 3X mirror
 Miroir grossissant 3X mural
 Vergrößerungsspiegel Wandmodell 3X
 Ø 185 ↑ 222 ↗ 130

Disponibile anche / Available also
 Disponible en / Verfügbar also
 .5X magnifying - .8X magnifying



55852.29 Specchio ingranditore 1 lato riflettente ed 1 lato ingrandente 3X, a parete

Wall mirror; 1 side magnifying 3X, 1 side true image
 Miroir grossissant 3X et normal (2 côtés), mural
 Vergrößerungsspiegel (nur eine Seite Vergrößerung 3X) Wandmodell
 → 290 ↑ 290 ↗ 60 - 395



55851.29 Specchio ingranditore 1 lato riflettente ed 1 lato ingrandente 3X, da appoggio

Table mirror; 1 side magnifying 3X, 1 side true image
 Miroir grossissant 3X et normal (2 côtés), à poser
 Vergrößerungsspiegel (nur eine Seite Vergrößerung 3X) Standmodell
 Ø 140 ↑ 395 ↗ 230



5581.29 Specchio ingranditore 3X luce LED da appoggio

Magnifying 3X table mirror with LED light
 Miroir grossissant 3X à poser avec lumière LED
 Vergrößerungsspiegel 3X LED Licht Standmodell
 Ø 215 ↑ 455 ↗ 158



5583.29 Specchio ingranditore 3X luce LED a parete

Magnifying 3X wall mirror with LED light
 Miroir grossissant 3X mural avec lumière LED
 Vergrößerungsspiegel 3X LED Licht Wandmodell
 Ø 215 ↗ 115 - 358





5584.29 Specchio ingranditore 3X luce LED a parete

Magnifying 3X wall mirror with LED light

Miroir grossissant 3X mural avec lumière LED

Vergrößerungsspiegel 3X LED Licht Wandmodell

∅ 250 ↗ 120 - 360



55864 Specchio ingranditore 5X da appoggio con contenitore

Magnifying 5X table mirror with container

Miroir grossissant 5X avec récipient

Vergrößerungsspiegel 5X mit Container

→ 210 ↑ 230 ↗ 105



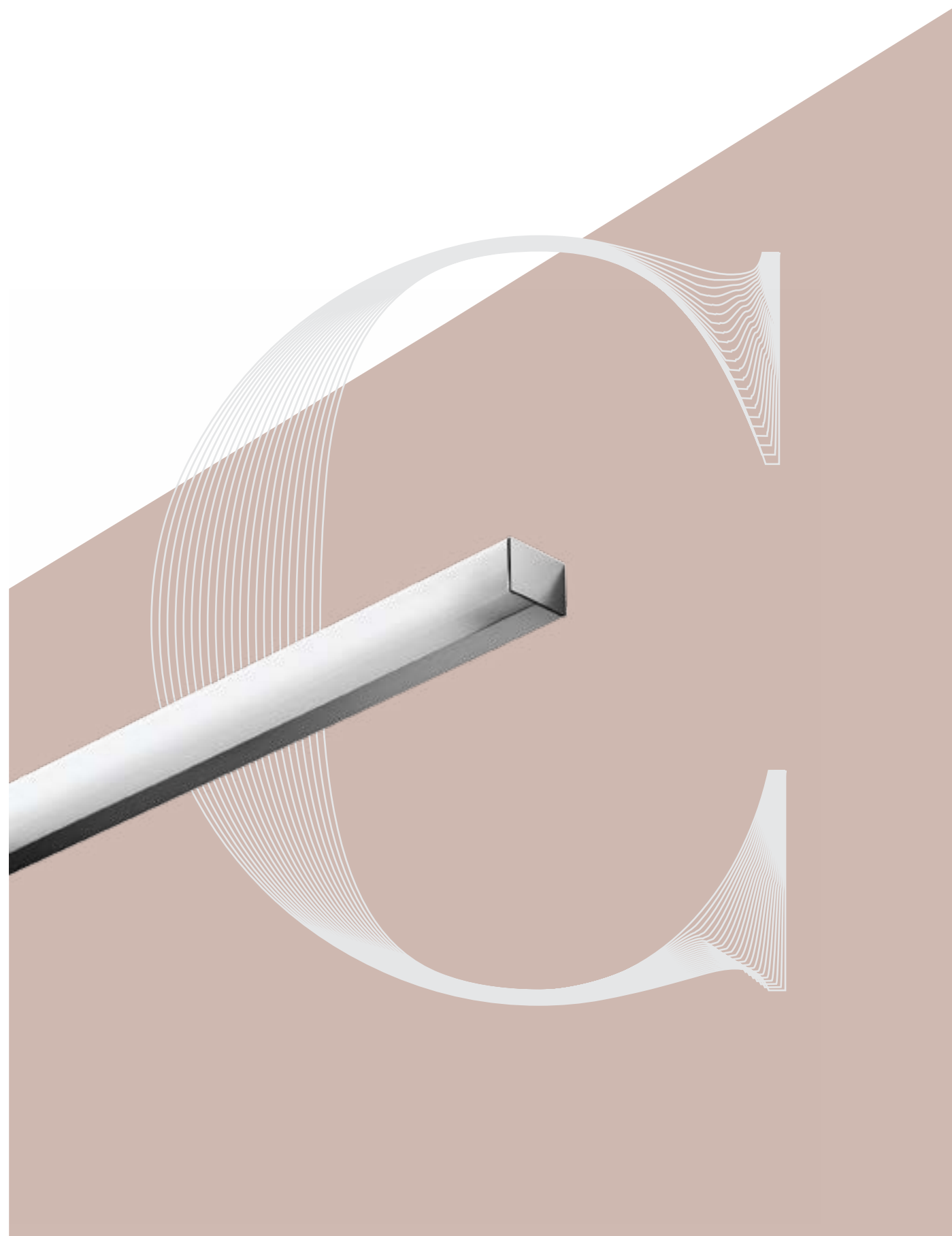

Chiari. Collezione di lampade a LED, ad alta efficienza luminosa. Dotate di certificazione IP44, a muro o a specchio, in ottone cromato o alluminio verniciato.

EN~ *Clear. Collection of high efficiency IP44 certified LED and halogen lamps compatible with SPECI mirrors.*

FR~ *Collection de lampes LED, à grande efficacité lumineuse et halogènes. Doté de la certification IP44, mural ou à miroir, en laiton chromé ou aluminium verni.*

DE~ *Sammlung von LED-Lampen, mit hoher Lichtausbeute und Halogen. Ausgestattet mit IP44-Zertifizierung, für die Wand oder Spiegel, verchromtes oder lackiertes Aluminium und Messing.*



5726

57014

57023

57030

5708



5707

5720

5721

5722

5723

5726.29 Lampada LED per specchio 12W / 110-220V

LED lamp to fix on mirror 12W / 110-220V

Lampe LED pour miroir 12W / 110-220V

Spiegelleuchte LED 12W/110-220V

→ 740 ↑ 35 ↗ 105



57014 Lampada a LED a parete

Wall LED lamp

Lampe LED murale

Wandleuchte LED

→ 320 ↑ 81,5 ↗ 56



57023.29 Lampada a LED per specchio

LED lamp to fix on mirror

Lampe LED pour miroir

Spiegelleuchte LED

∅ 36 ↑ 210 ↗ 100



57030.29 Plafoniera a LED, montaggio verticale e orizzontale

LED lamp, vertical and horizontal mounting

Plafonnier LED, montage en position vertical ou horizontal

LED-Wandlampe Waagerechte / Senkgerechte Montage

→ 600 ↑ 57 ↗ 40



5707 Plafoniera a LED, montaggio verticale e orizzontale

LED lamp, vertical and horizontal mounting

Plafonnier LED, montage en position vertical ou horizontal

LED-Wandlampe Waagerechte / Senkgerechte Montage

→ 700 ↑ 55 ↗ 100

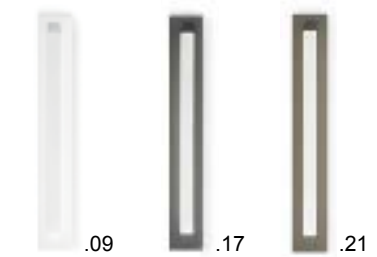

5708 Plafoniera a LED

Ceiling light

Lampe LED

LED-Lampe

∅ 400 ↑ 85



5720.29 Lampada LED a specchio

LED lamp to fix on mirror

Lampe LED pour miroir

Spiegelleuchte LED

→ 30 ↑ 175 ↗ 255



5721.29 Lampada LED a specchio

LED lamp to fix on mirror

Lampe LED pour miroir

Spiegelleuchte LED

→ 30 ↑ 70 ↗ 200



5722.29 Lampada LED a specchio

LED lamp to fix on mirror

Lampe LED pour miroir

Spiegelleuchte LED

→ 300 ↑ 35 ↗ 110



5723.29 Lampada LED a specchio

LED lamp to fix on mirror

Lampe LED pour miroir

Spiegelleuchte LED

→ 400 ↑ 129 ↗ 170





CODICE IP (EN 60529)

Sistema che indica i gradi di protezione di un involucro contro l'accesso a parti pericolose, la penetrazione di corpi solidi, e/o l'ingresso di acqua.

PROTEZIONE CONTRO L'INGRESSO DI SOLIDI

IP0X non protetto

IP1X contro corpi estranei > 50 mm

IP2X contro corpi estranei > 12 mm

IP3X contro corpi estranei > 2,5 mm / **IP4X** contro corpi estranei > 1 mm

IP5X protezione da polvere

IP6X stagno alla polvere

PROTEZIONE CONTRO L'INGRESSO DI LIQUIDI

IPX0 non protetto

IPX1 contro la caduta vertical di gocce

IPX2 contro caduta acqua con inclinazione 15°

IPX3 contro la pioggia

IPX4 contro gli spruzzi

IPX5 contro i getti acqua

IPX6 contro i getti potenti

IPX7 contro l'immersione temporanea

IPX8 contro l'immersione continua

CERTIFICAZIONI

TUV Rheinland GS è un certificato fornito dal produttore che attesta l'ammissione in Europa. Dimostrando la totale conformità con GPSG (legge tedesca sulla sicurezza del prodotto) per la Germania, ma anche dimostra la conformità con l'LVD, legge dell'unione europea che assicura che un apparecchio elettrico con certi limiti di voltaggio, offre comunque un alto livello di protezione.

CLASSI DI ISOLAMENTO

CLASSE I

La protezione non si basa unicamente sull'isolamento principale, ma anche su una misura di sicurezza supplementare costituita dalla connessione delle parti conduttrici accessibili ad un conduttore di protezione (messa a terra di protezione) che fa capo all'impianto elettrico fisso, in modo tale che le parti

conduttrici accessibili non possano andare in tensione in caso di guasto dell'isolamento principale.

CLASSE II

Gli apparecchi di classe II sono progettati in modo da non richiedere la connessione di messa a terra. Sono costruiti in modo che un singolo guasto non possa causare il contatto con tensioni pericolose da parte dell'utilizzatore. Ciò è ottenuto realizzando l'involucro del contenitore in materiali isolanti, o comunque facendo in modo che le parti in tensione siano circondate da un doppio strato di materiale isolante o usando isolamenti rinforzati.

CLASSE III

Un apparecchio viene definito di Classe III quando la protezione contro la folgorazione si affida al fatto che non sono presenti tensioni superiori alla Bassissima tensione di sicurezza SELV (Safety Extra-Low Voltage). In pratica tale apparecchio viene alimentato o da una batteria o da un trasformatore SELV.

NORMATIVE TECNICHE

Le direttive 89/336/CEE e 73/23/CEE stabiliscono i requisiti essenziali di sicurezza e compatibilità elettromagnetica a cui devono rispondere i materiali elettrici per poter circolare liberamente all'interno del mercato Europeo. Questi requisiti devono essere verificati mediante opportune prove tecniche e la conformità del materiale deve essere indicata mediante l'apposizione del marchio CE sul prodotto o sul suo imballo. La marchiatura è obbligatoria ed il produttore è direttamente responsabile della rispondenza del prodotto ai requisiti essenziali delle direttive sopracitate. La vendita, la commercializzazione e l'acquisto di prodotti privi della marcatura, e quindi non rispondenti alle direttive, è punita a termini di legge.

ZONE DI SICUREZZA

Tutti gli apparecchi elettrici vanno collegati al circuito mantenendo una distanza minima di 0,60 m da lavabi, cabine doccia, vasche e 1,20 m da soffioni doccia.



IP CODE (EN 60529)

A coding system to indicate the degree of protection provided by an enclosure against accessing of solid foreign objects and/or water.

PROTECTION AGAINST THE INGRESS OF SOLIDS

IP0X not protected

IP1X against solid foreign objects > 50 mm

IP2X against solid foreign objects > 12 mm

IP3X against solid foreign objects > 2,5 mm / **IP4X** against solid foreign objects > 1 mm

IP5X dust protected

IP6X dust-tight

PROTECTION AGAINST THE INGRESS OF LIQUIDS

IPX0 not protected

IPX1 against vertically dripping

IPX2 against 15° tilted dripping

IPX3 rain protected

IPX4 splashing protected

IPX5 jetting protected

IPX6 powerful jetting protected

IPX7 against temporary immersion

IPX8 against continuous immersion

CERTIFICATES

The TUV Rheinland GS is a certificate presented by manufacturers as the proof for acceptance into Europe. It demonstrates full compliance with the GPSG (German equipment safety law) for Germany, but it also demonstrates compliance to the LVD that ensures that electrical equipment within certain voltage limits provides a high level of protection in the

CLASS LUMINAIRES

CLASSE I

Provide protection against electrical shock solely using the base insulation and the safe connection of all exposed conductive parts to an earth conductor.

CLASSE II

Provide protection against electrical shock using both the base insulation and an additional or reinforced insulation. This kind of products do not feature a connection to a protective earth conductor.

CLASSE III

Luminaires provide protection against electrical shock by using Safety Extra Low Voltage (SELV). This kind of products are not permitted to generate higher voltages than the Safety Extra Low Voltage.

NORMATIVE NOTES

The directives 89/336/EEC and 73/23/EEC establish the essential requirements for safety and electromagnetic compatibility that the electric and electronic equipment shall comply for freely circulating in the European market. These requirements must be verified by appropriate tests and compliance of the material must be indicated by the CE marking on the product or its packaging. This marking is mandatory and the producer is directly responsible for product compliance with the essential requirements of the abovementioned Directives. The sale, marketing and purchase of products without the markup, and therefore not meet the guidelines, shall be punished by law.

SAFETY ZONES

Electric appliances must be wired to the electric circuit in a minimum distance of 0,60 m from shower cabins, bath tubs, washbasins and of 1,20 m from shower heads.



CODE IP (EN 60529)

Système qui indique les degrés de protection d'un emballage contre l'accès à des parties dangereuses, la pénétration de corps solides, et/ou la pénétration de l'eau.

PROTECTION CONTRE LA PÉNÉTRATION DE SOLIDES

IP0X non protégé

IP1X contre les corps étrangers > 50 mm

IP2X contre les corps étrangers > 12 mm

IP3X contre les corps étrangers > 2,5 mm IP4X contre les corps étrangers > 1 mm

IP5X protection contre la poussière

IP6X étanche à la poussière

PROTECTION CONTRE LA PÉNÉTRATION DE LIQUIDES

IPX0 non protégé

IPX1 contre la chute verticale de gouttes

IPX2 contre la chute d'eau à 15° d'inclinaison

IPX3 contre la pluie

IPX4 contre les éclaboussures

IPX5 contre les jets d'eau

IPX6 contre les jets puissants

IPX7 contre l'immersion temporaire

IPX8 contre l'immersion continue

CERTIFICATIONS

TUV Rheinland GS est un certificat fourni par le producteur qui atteste l'admission en Europe. En démontrant la totale conformité au GPSG (loi allemande sur la sécurité du produit) pour l'Allemagne, elle démontre aussi la conformité avec la LVD – loi de l'Union Européenne qui assure qu'un appareil électrique avec certaines limites de voltage offre tout de même un haut niveau de protection.

CLASSES D'ISOLATION

CLASSE I

La protection n'est pas seulement basée sur l'isolation principale, mais également sur une mesure de sécurité supplémentaire constituée de la connexion des parties conductrices accessibles à un conducteur de protection (protection vers la terre) qui est

rattaché à l'installation électrique fixe, de sorte que les parties conductrices accessibles ne puissent être mises sous tension en cas de panne de l'isolation principale.

CLASSE II

Les dispositifs de classe II sont conçus de sorte à ne pas avoir besoin de connexion à la terre. Ils sont fabriqués de façon à ce qu'une simple panne ne puisse causer le contact avec des tensions dangereuses de la part de l'utilisateur. Ce résultat est obtenu en fabriquant l'enveloppe du conteneur en matériau isolant, ou, en tout état de fait, en faisant en sorte que les parties sous tension soit entourées d'une double couche de matériau isolant, ou en utilisant une isolation renforcée.

CLASSE III

Un appareil est défini de Classe III lorsque sa protection contre l'électrocution est due au fait qu'aucune tension supérieure à la tension basse de sécurité SELV (Safety Extra-Low Voltage) n'est présente. Dans la pratique, cet appareil est alimenté soit par une batterie, soit par un transformateur SELV.

RÉGLEMENTATIONS TECHNIQUES

Les directives 89/336/CEE et 73/23/CEE établissent les exigences essentielles de sécurité et compatibilité électromagnétique auxquelles doivent répondre les matériaux électriques afin de pouvoir circuler librement sur le marché européen. Ces exigences doivent être vérifiées par des tests techniques appropriés et la conformité du matériau doit être indiquée par l'apposition de la marque CE sur le produit ou sur son emballage. Le marquage est obligatoire et le producteur est directement responsable de l'adéquation du produit aux exigences essentielles des directives susmentionnées. La vente, la commercialisation et l'achat de produits privés de ce marquage, et donc ne répondant pas aux directives, est puni en terme de loi.

ZONE DE SÉCURITÉ

Tous les appareils électriques sont reliés au circuit en maintenant une distance minimale de 0,60 m des lavabos, cabines de douche, baignoires et de 1,20 m des pommeaux de douche.



IP CODE (EN 60529)

System, das den Grad der Schutzklasse für den Zugang zu gefährlichen Teilen anzeigt, um das Eindringen von Festkörpern und / oder das Eindringen von Wasser zu verhindern.

SCHUTZ VOR DEM EINDRINGEN VON FESTSTOFFEN

IP0X ungeschützt

IP1X gegen Fremdkörper > 50 mm

IP2X gegen Fremdkörper > 12 mm

IP3X gegen Fremdkörper > 2,5 mm IP4X gegen Fremdkörper > 1 mm

IP5X Schutz vor Staub

IP6X staubdicht

SCHUTZ VOR DEM EINDRINGEN VON FLÜSSIGKEITEN

IPX0 ungeschützt

IPX1 gegen den vertikalen Fall von Tropfen

IPX2 gegen fallende Wasser mit 15° Neigung

IPX3 gegen Regen

IPX4 gegen Spritzer

IPX5 gegen Strahlwasser

IPX6 gegen starken Strahl

IPX7 gegen zeitweiliges Untertauchen

IPX8 gegen dauerndes Untertauchen

ZERTIFIZIERUNGEN

TÜV Rheinland GS ist ein Zertifikat vom Hersteller, um die Zulassung in Europa zu zertifizieren. Mit dem Nachweis voller Übereinstimmung mit der GPSG (deutsches Recht auf Sicherheitsprodukte) nicht nur für Deutschland, sondern auch in Übereinstimmung mit dem LVD, Gesetz der Europäischen Union zum Nachweis der Übereinstimmung, die ein elektrisches Gerät mit bestimmten Spannungsgrenzen gewährleistet, wobei ein hohes Niveau an Schutz geboten wird.

ISOLIERKLASSEN

KLASSE I

Der Schutz basiert nicht nur auf der Hauptisolation, sondern auch auf einer zusätzlichen Sicherheitsmaßnahme durch die Verbindung der leitenden Teile über einem Schutzleiter (geerdet), der zur

feststehenden elektrischen Installation gehört, in der Weise, dass leitfähige Teile nicht unter Spannung gesetzt werden, falls es zu einem Ausfall der Hauptisolation kommt.

KLASSE II

Die Klasse-II-Geräte sind so konzipiert, damit sie keine Masseverbindung benötigen. Sie sind so konstruiert, dass ein einzelner Fehler nicht zum Kontakt mit gefährlichen Spannungen für den Benutzer führt. Dies wird durch die Konzeption des Behältermantels in Isoliermaterialien erreicht, oder auf andere Weise, so dass die stromführenden Teile durch eine Doppelschicht aus isolierendem Material oder durch Verwendung von verstärkter Isolierung umgeben sind.

KLASSE III

Eine Einheit ist definiert als Klasse III, wenn der Schutz gegen elektrischen Schlag auf der Tatsache beruht, dass die Spannungen nur als sehr niedrige Sicherheitsspannungen SELV (Extra Low Voltage Safety) anliegen. In der Praxis wird dies durch eine Batterie oder durch einen SELV Transformator sichergestellt.

TECHNISCHE STANDARDS

Richtlinien 89/336 / EWG und 73/23 / EWG Festlegung der grundlegenden Sicherheitsanforderungen und EMV-Anforderungen für elektrische Materialien auf dem europäischen Markt. Diese Anforderungen müssen durch geeignete technische Tests und die Konformität des Materials überprüft werden, und werden angezeigt durch das CE-Zeichen auf dem Produkt oder der Verpackung. Die Kennzeichnung ist obligatorisch und der Hersteller ist direkt verantwortlich für die Produktkonformität mit den grundlegenden Anforderungen der oben genannten Richtlinien. Der Vertrieb, Marketing und der Kauf von Produkten ohne Beschriftung ist daher nicht im Einklang mit Richtlinien und strafbar.

SICHERHEITSSZONE

Alle elektrischen Geräte werden mit der Schaltung verbunden, indem ein Mindestabstand von 0,60 m von Waschbecken gehalten wird, von Duschkabinen und Badewannen und 1,20 m von Duschköpfen.



Collezione Termoarredi
Design Radiators Collection
Collection Radiateurs
Kollektion Heizkörper

CALIGO

Termoarredi verniciati / Painted radiators /
Radiateurs vernis / Heizkörper lackiert

285

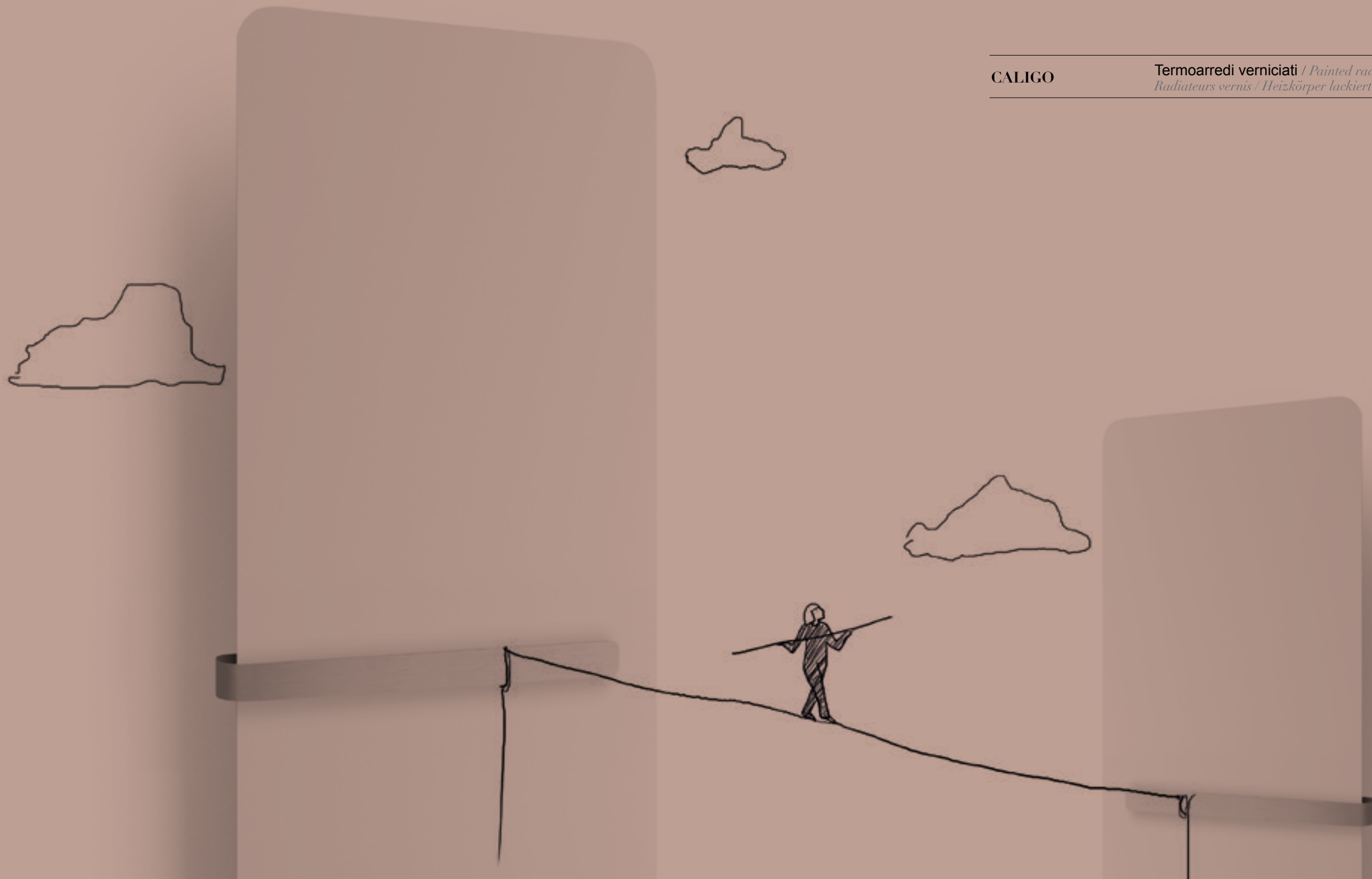



Bruma di calore (Ca-li-gò).
 Caligo è il termoarredo secondo Lineabeta. Il più sottile sul mercato, garantisce un elevato risparmio energetico garantendo una eccellente potenza termica. Disponibile in varie misure, può essere ad acqua o elettrico.

EN~ *Heat fog. Bruma. Caligo is the radiator according Lineabeta. The thinnest on the market, it provides a high energy saving and at the same time it ensures an excellent thermal power. Available in various sizes and electric.*

FR~ *(Ca-li-gò) Brume de chaleur. Caligo est le radiateur selon Lineabeta. Le plus fin du marché il permet une forte économie énergétique, tout en garantissant une excellente puissance thermique. Disponible en différentes tailles et électrique.*

DE~ *(Ca-li-gò) Etwas Wärme. Caligo ist der Strahler in der Sprache von Lineabeta. Die dünnste auf dem Markt, eine hohe Energieeinsparung bietet durch eine hervorragende thermische Leistung zu gewährleisten. Erhältlich in verschiedenen Größen und elektrisch.*



7

Spessore 7 mm

7 mm thickness 7 mm espesor
7 mm Dicke



Design essenziale

Essential design Schlichtes Design
Design essentiel



Alta efficienza energetica

High energy efficiency Hohe Energieeffizienz
Haute efficacité énergétique

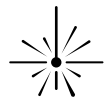

Saldatura laser

Laser welding Laserschweißen
Soudage laser

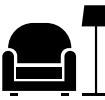

Uso versatile

Versatile placing Vielseitig Platzierung
Versatile mise

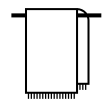

Portasalviette

Towel holder included Handtuchhalter enthalten
Porte-serviettes inclus



Facile da installare

Easy to install Einfach zu installieren
Facile à installer



Facile da pulire

Easy to clean Einfach zu säubern
Facile à nettoyer





.09



.17



.21

7501 Termoarredo a muro con 1 portasalviette

Radiator with 1 towel holder

Radiateur avec 1 porte-serviettes

Heizkörper mit 1 Handtuchhalter

→ 470 ↑ 1190 ↗ 66 - 96



Resa Termica / Thermal Efficiency				Esponente	Volume acqua	Peso
ΔT = 50K (EN 442)	ΔT = 60K	70/55/24	55/45/24	Exponent	Water volume	Weight
Watt	Watt	Watt	Watt	n	dm3	kg
523	662	373	225	1,2907	1,1	17,5
Assi Idraulici da centro a centro		Assi montaggio orizzontali		Assi montaggio verticali	Da inizio montaggio a fine prodotto	
Hydraulic axes center to center		Horizontal mounting axes		Vertical mounting axes	From mounting start to product end	
mm		mm		mm	mm	
50 (looking up)		270		560	860	



.09



.17



.21

7502 Termoarredo a muro con 1 portasalviette

Radiator with 1 towel holder

Radiateur avec 1 porte-serviettes

Heizkörper mit 1 Handtuchhalter

→ 470 ↑ 1590 ↗ 66 - 96



Resa Termica / Thermal Efficiency				Esponente	Volume acqua	Peso
ΔT = 50K (EN 442)	ΔT = 60K	70/55/24	55/45/24	Exponent	Water volume	Weight
Watt	Watt	Watt	Watt	n	dm3	kg
700	886	500	302	1,2907	1,5	23
Assi Idraulici da centro a centro		Assi montaggio orizzontali		Assi montaggio verticali	Da inizio montaggio a fine prodotto	
Hydraulic axes center to center		Horizontal mounting axes		Vertical mounting axes	From mounting start to product end	
mm		mm		mm	mm	
50 (looking up)		270		980	1320	

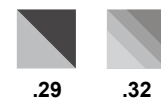

.29 .32

75092 Portasalvietta per termoarredo ad acqua 470 mm

Towel bar for water radiator 470 mm

Barre porte-serviettes pour radiateur eau chaud 470 mm

Handtuchhalter für Heizkörper 470 mm

→ 470 ↑ 35 ↗ 75

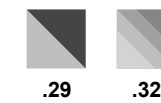

.29 .32

75092 Portasalvietta per termoarredo ad acqua 470 mm

Towel bar for water radiator 470 mm

Barre porte-serviettes pour radiateur eau chaud 470 mm

Handtuchhalter für Heizkörper 470 mm

→ 470 ↑ 35 ↗ 75





7503 Termoarredo a muro con 1 portasalviette

Radiator with 1 towel holder
Radiateur avec 1 porte-serviettes
Heizkörper mit 1 Handtuchhalter

→ 570 ↑ 1790 ↗ 66 - 96



Resa Termica / Thermal Efficiency				Esponente	Volume acqua	Peso	
ΔT = 50K (EN 442)	ΔT = 60K	70/55/24	55/45/24	Exponent	Water volume	Weight	
Watt	Watt	Watt	Watt	n	dm3	kg	
960	1214	685	413	1,2882	2	31	
Assi Idraulici da centro a centro		Assi montaggio orizzontali		Assi montaggio verticali	Da inizio montaggio a fine prodotto		
Hydraulic axes center to center		Horizontal mounting axes		Vertical mounting axes	From mounting start to product end		
mm		mm		mm	mm		
50 (looking up)		270		1120	1450		

7504 Termoarredo a muro elettrico con 1 portasalviette

Electric radiator with 1 towel holder
Radiateur électrique avec 1 porte-serviettes
Elektrischer Heizkörper mit 1 Handtuchhalter

→ 470 ↑ 1790 ↗ 66 - 96



Resa Termica / Thermal Efficiency		Peso	ARTICOLO FORNITO CON LIQUIDO TERMOVETTORE E RESISTENZA ELETTRICA 7511 O 7512. A SCELTA PRODUCT INCLUDE CONVECTOR LIQUID AND ELECTRIC RESISTANCE 7511 OR 7512, TO BE CHOSEN
resistenza / resistance 5211, 5212		Weight	
Watt		kg	
max 800		26,5	
Assi Idraulici da centro a centro	Assi montaggio orizzontali	Assi montaggio verticali	Da inizio montaggio a fine prodotto
Hydraulic axes center to center	Horizontal mounting axes	Vertical mounting axes	From mounting start to product end
mm	mm	mm	mm
-	270	1120	1450

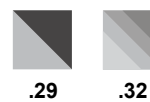

75093 Portasalvietta per termoarredo ad acqua 570 mm

Towel bar for water radiator 570 mm
Barre porte-serviettes pour radiateur eau chaude 570 mm
Handtuchhalter für Heizkörper 570 mm

→ 570 ↑ 35 ↗ 75

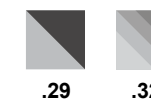

7509 Portasalvietta per termoarredo elettrico 470 mm

Towel bar for electric radiator 470 mm
Barre porte-serviettes pour radiateur électrique 470 mm
Handtuchhalter für Heizkörper 470 mm

→ 470 ↑ 35 ↗ 75



7511.09 Resistenza elettrica on / off

Electrical resistance
Résistance électrique on/off
Elektrischer Widerstand on/off
 Ø 43 ↑ 520



7512.09 Resistenza elettrica con timer e regolazione temperatura

Heating element for electrical radiators with timer and temperature control
Résistance électrique avec timer et régulateur de température
Elektrischer Widerstand mit Timer und Temperaturregelung
 → 56 ↑ 550 ↗ 67



7510.29 Gruppo valvola e detentore 50 mm - destro

Thermostatic lockshield valve 50 mm - right
Groupe vanne et détendeur, 50 mm, droit
Ventile Detentoren 50 mm rechts
 → 154 ↑ 70 ↗ 42



7515.29 Testa termostatica cromo per gruppo valvola

Thermostatic head for valve group
Vanne thermostatique
Ventile Thermostatisch
 Ø 41 ↑ 87,3



7516.29 Kit copritubo 50 mm

Tube cover kit 50 mm
Kit cache-tuyau 50 mm
Rohrabdeckungs-Set 50 mm
 → 100 ↑ 50 ↗ 12



7517.29 Kit raccordi per tubo rame e multistrato

Copper and multilayer collar kit
Kit raccords pour tuyaux
Anschlussstück aus Kupfer



52964.29 Appendino per termoarredo e box doccia

Hook for radiator and shower box
Patère pour radiateur et douche
Hacken für Heizkörper und Duschkabine
 → 25 ↑ 125 ↗ 40





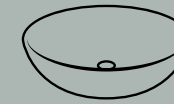

Collezione Lavabi
Washbasins Collection
Collections Lavabos
Kollektion Waschbecken



QUARELO	Lavabi ceramica / Ceramic washbasins / Lavabos en céramique / Waschbecken aus Keramik	299
MOMON	Lavabi mattstone / Mattstone washbasins / Lavabos en mattstone / Waschbecken aus Mattstone	303
ACQUAIO	Vasche appoggio / Countertop washbasins / Lavabos à poser / Aufsatzbecken	309
GOTO	Set supporto vasche / Wall bearing washbasins set / Sets support pour lavabos / Halter für Waschbecken	315
CIUCI	Lavamani mattstone / Mattstone washbasins / Lave-mains en mattstone / Waschbecken aus Mattstone	317
POCIA	Lavamani vetro / Glass washbasins / Lave-mains en verre / Waschbecken aus Glas	319
GALATEO	Lavabi ceramica / Ceramic washbasins / Lave-mains en céramique / Waschbecken aus Keramik	321



00

QUARELO

Mattone. Serie di lavabi in ceramica bianca, le sue forme minimali la rendono adatta a qualsiasi ambiente. Disponibile nelle versioni da appoggio o a muro.

EN~ *Brick. White ceramic ashbasin collection. Minimal design makes it flexible and adaptable into every bath. Available with wall or countertop options.*

FR~ *Série de lavabos en céramique blanche, ses formes minimales le rendent adapté à tout type d'environnement. Disponible en version posée ou murale.*

DE~ *Weißer Keramik-Waschbecken-Serie, seine minimalistischen Formen machen es für jede Umgebung geeignet. Erhältlich als Arbeitsplatte oder Wand-Version.*

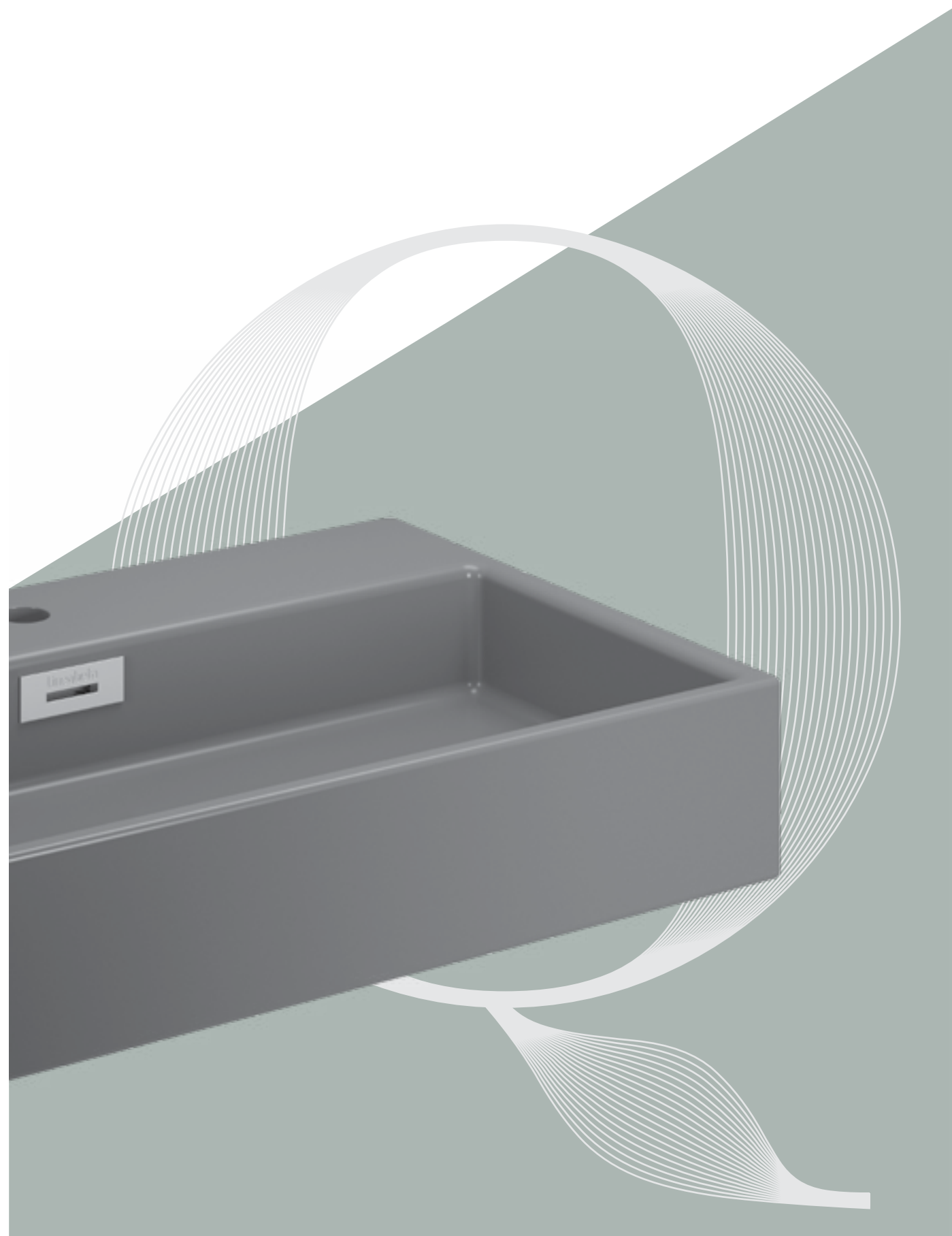

53703



53706 - 537061



53708 - 537081



53709 - 537091



53710 - 537101



53711 - 53712



53703 Lavabo in ceramica senza piletta

Ceramic washbasin without waste water drain

Lavabo en céramique à poser, sans bonde

Keramikbecken ohne Ablaufgarnitur

→ 585 ↑ 145 ↗ 365

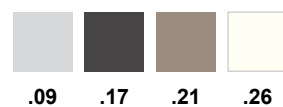

53706.29 Lavabo in ceramica a muro con piletta scarico libero 53971, senza troppopieno

Ceramic wall washbasin with free waste water drain 53971, without overflow

Lavabo en céramique mural avec bonde à écoulement libre 53971, sans trop-plein

Keramikbecken mit freie Abalufgarnitur 53971, ohne Überlauf

→ 320 ↑ 115 ↗ 280

537061.09 Senza foro rubinetto

Without tap hole

Sans perçage de robinetterie

Ohne Loch für Armatur



53708 Lavabo in ceramica appoggio o sospeso a muro, senza piletta

Ceramic wall countertop washbasin, without waste water drain

Lavabo en céramique à accrocher au mur ou poser, sans bonde

Keramikbecken ohne Ablaufgarnitur Wandmontage od. Aufzusetzen

→ 420 ↑ 130 ↗ 360

537081.09 Senza foro rubinetto

Without tap hole

Sans perçage de robinetterie

Ohne Loch für Armatur

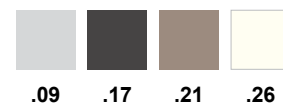

53709 Lavabo in ceramica da appoggio o sospeso a muro, senza piletta

Ceramic wall countertop washbasin, without waste water drain

Lavabo en céramique à accrocher au mur ou poser, sans bonde

Keramikbecken ohne Ablaufgarnitur Wandmontage od. Aufzusetzen

→ 495 ↑ 125 ↗ 420

537091.09 Senza foro rubinetto

Without tap hole

Sans perçage de robinetterie

Ohne Loch für Armatur

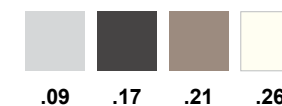

53710 Lavabo in ceramica da appoggio o sospeso a muro, senza piletta

Ceramic wall countertop washbasin, without waste water drain

Lavabo en céramique à accrocher au mur ou poser, sans bonde

Keramikbecken ohne Ablaufgarnitur Wandmontage od. Aufzusetzen

→ 695 ↑ 130 ↗ 420

537101.09 Senza foro rubinetto

Without tap hole

Sans perçage de robinetterie

Ohne Loch für Armatur



53711 Lavabo in ceramica senza piletta con troppopieno

Ceramic washbasin without waste water drain with overflow

Lavabo en céramique à poser, sans bonde avec trop-plein

Keramikbecken ohne Ablaufgarnitur mit Überlauf

→ 610 ↑ 160 ↗ 450

53712 → 550 ↑ 160 ↗ 420





Caramelle. Serie di lavabi dalle linee essenziali, tonde o quadrate in mattstone bianco, ossia materiale sintetico, solido e resistente, non poroso, quindi molto igienico. Disponibili nelle varianti da appoggio, a muro o free standing.

EN~ *Candy; sweet. Washbasins designed with round or square essential lines and made of white mattstone: a synthetic, solid, durable, nonporous and very hygienic material. Available in countertop, wall or freestanding variations.*

FR~ *Série de lavabos aux lignes essentielles, rondes ou carrées en pierre composite blanche, un matériau synthétique solide et résistant, non-poreux, et donc très hygiénique. Disponible dans les variantes posée, murale ou autoportante.*

DE~ *Serie von Waschbecken mit essentiellen Linien, rund oder eckig in mattstone weiß, ein Kunststoff, der solide und langlebig ist, porenfrei, und daher sehr hygienisch. Erhältlich in den Variationen für die Wand oder freistehend.*



53553

53555

53556

53559
535591

53560

53561

53564

53563

53553.26 Lavabo in mattstone da appoggio, completo di piletta a scarico libero

Mattstone countertop washbasin, with free waste water drain

Lavabo à poser en mattstone, avec bonde à écoulement libre

Aufsatzbecken aus Mattstone mit freie Ablaufgarnitur

→ 500 ↑ 125 ↗ 350



Lavabo in mattstone da appoggio, completo di piletta scarico libero

Mattstone countertop washbasin, with free waste water drain

Lavabo à poser en mattstone, avec bonde écoulement libre

Aufsatzbecken aus Mattstone mit freie Ablaufgarnitur

53555.26 → 480 ↑ 120 ↗ 430

53556.26 → 680 ↑ 120 ↗ 430

53559.26 Lavabo in mattstone centro stanza con foro rubinetto, completo di piletta a scarico libero

Mattstone pedestal washbasin, with tap hole, with freeflow waste water drain

Lavabo sur piédestal en mattstone, avec perçage de robinetterie, bonde à écoulement libre

Piedestal Waschbecken aus Mattstone mit Hahnloch und freie Ablaufgarnitur

Ø 455 ↑ 900

535591.26 Senza apertura sifone nella parte posteriore

Without back siphon hole

Sans ouverture pour siphon dans la partie postérieure

Ohne Erfönnung für Siphon auf die Ruckseite



53560.26 Lavabo in mattstone centro stanza senza foro rubinetto, completo di piletta a scarico libero e sifone a pavimento

Mattstone pedestal washbasin, without tap hole, with free waste water drain and floor siphon

Lavabo sur piédestal en mattstone sans trou de robinetterie, avec bonde à écoulement libre et siphon au sol

Piedestal Waschbecken aus Mattstone ohne Hahnloch mit freie Ablaufgarnitur und Siphon am Boden

Ø 455 ↑ 900



53561.26 Lavabo da appoggio in mattstone con piletta a scarico libero

Mattstone countertop washbasin with freeflow wastewater drain

Lavabo à poser en mattstone avec bonde à écoulement libre

Aufsatzbecken aus Mattstone mit freie Ablaufgarnitur

→ 600 ↑ 125 ↗ 350



53564.26 Lavabo in mattstone da appoggio con piletta a scarico libero

Mattstone countertop washbasin with freeflow wastewater drain

Lavabo à poser en mattstone avec bonde à écoulement libre

Aufsatzbecken aus Mattstone mit freie Ablaufgarnitur

Ø 400 ↑ 125



53563.26 Lavabo in mattstone da appoggio con piletta a scarico libero

Mattstone countertop washbasin with freeflow wastewater drain

Lavabo à poser en mattstone avec bonde à écoulement libre

Aufsatzbecken aus Mattstone mit freie Ablaufgarnitur

Ø 390 ↑ 400



S ecchio. Serie di lavabi in inox lucido, bambù, vetro stratificato e temperato o ceramica. I modelli in vetro temperato sono disponibili con molte finiture che permettono accostamenti sofisticati e innovativi.

EN~ *Bucket. Collection of stainless steel, bamboo, stratified and tempered glass or ceramic washbasins. Glass washbasins are available with lots of finishings that allows sophisticated and innovative matchings.*

FR~ *Série de lavabos en inox brillant, bambou, verre stratifié et trempé ou céramique. Les modèles en verre trempé sont disponibles avec de nombreuses finitions qui permettent des combinaisons sophistiquées et innovantes.*

DE~ *Serie von Becken in poliertem Edelstahl, Bambus, laminiert und aus gehärtetem Glas oder Keramik. Die Modelle aus gehärtetem Glas gibt es in vielen Oberflächen-Varianten, die anspruchsvolle und innovative Kombinationen ermöglichen.*



536983



536982



536985



536981



536991



53586 - 53596
53666



53593 - 53663



53694



53695



53696



53724



536983 Vasca ovale in ceramica da appoggio senza piletta

Oval ceramic countertop washbasin without free waste water drain

Lavabo oval en céramique à poser sans bonde

Ovales Aufsatzbecken aus Keramik ohne Ablaufgarnitur

→ 600 ↑ 148 ↗ 384



536981 Vasca tonda in ceramica da appoggio senza piletta

Round ceramic countertop washbasin without free waste water drain

Lavabo rond à poser en céramique sans bonde

Rundes Aufsatzbecken aus Keramik ohne Ablaufgarnitur

Ø 295 ↑ 100



536982 Vasca ovale in ceramica da appoggio senza piletta

Oval ceramic countertop washbasin without free waste water drain

Lavabo oval à poser en céramique sans bonde

Ovales Aufsatzbecken aus Keramik ohne Ablaufgarnitur

→ 500 ↑ 140 ↗ 385

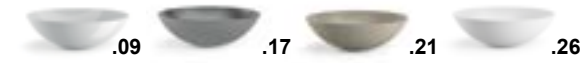

536991 Vasca tonda in ceramica da appoggio senza piletta

Round ceramic countertop washbasin without free waste water drain

Lavabo rond à poser en céramique sans bonde

Rundes Aufsatzbecken aus Keramik ohne Ablaufgarnitur

Ø 430 ↑ 130



536985 Vasca ovale in ceramica da appoggio senza piletta

Oval ceramic countertop washbasin without free waste water drain

Lavabo oval à poser en céramique sans bonde

Ovales Aufsatzbecken aus Keramik ohne Ablaufgarnitur

→ 480 ↑ 132 ↗ 335



Vasca tonda in acciaio lucido da appoggio

Round polished steel countertop washbasin

Lavabo rond à poser en acier poli

Rundes Aufsatzbecken aus Edelstahl glänzend

53586.29 Ø 245 ↑ 120

53596.29 Ø 290 ↑ 130

53666.29 Ø 390 ↑ 145





53696.29 Vasca in vetro con ghiera fissaggio

Glass washbasin with fixing ring

Lavabo à poser en verre avec base d'appui

Glasbecken mit Aufsatzring

Ø 425 ↑ 150



Vasca in acciaio lucido da incasso

Polished steel built-in washbasin

Lavabo à encastrer en acier poli

Einbauwaschtisch aus Edelstahl glänzend

53593.29 Ø 330 ↑ 135

53663.29 Ø 440 ↑ 165



53694.03 Vasca in bamboo da appoggio

Bamboo countertop washbasin

Lavabo à poser en bambou

Waschbecken aus Bamboo Holz

Ø 430 ↑ 160



53695.29 Vasca in vetro con ghiera fissaggio

Glass washbasin with fixing ring

Lavabo à poser en verre avec base d'appui

Glasbecken mit Aufsatzring

Ø 300 ↑ 110



53724.09 Lavabo a muro in poliuretano espanso con vasca inox verniciata a polveri

Wall hanging polyurethane washbasin with dust painted inox basin

Lavabo mural en polyuréthane expansé avec vasque en acier vernis

Waschbecken aus Styropor mit Wandanschluss und lackiertem Becken

→ 380 ↑ 455 ↗ 455



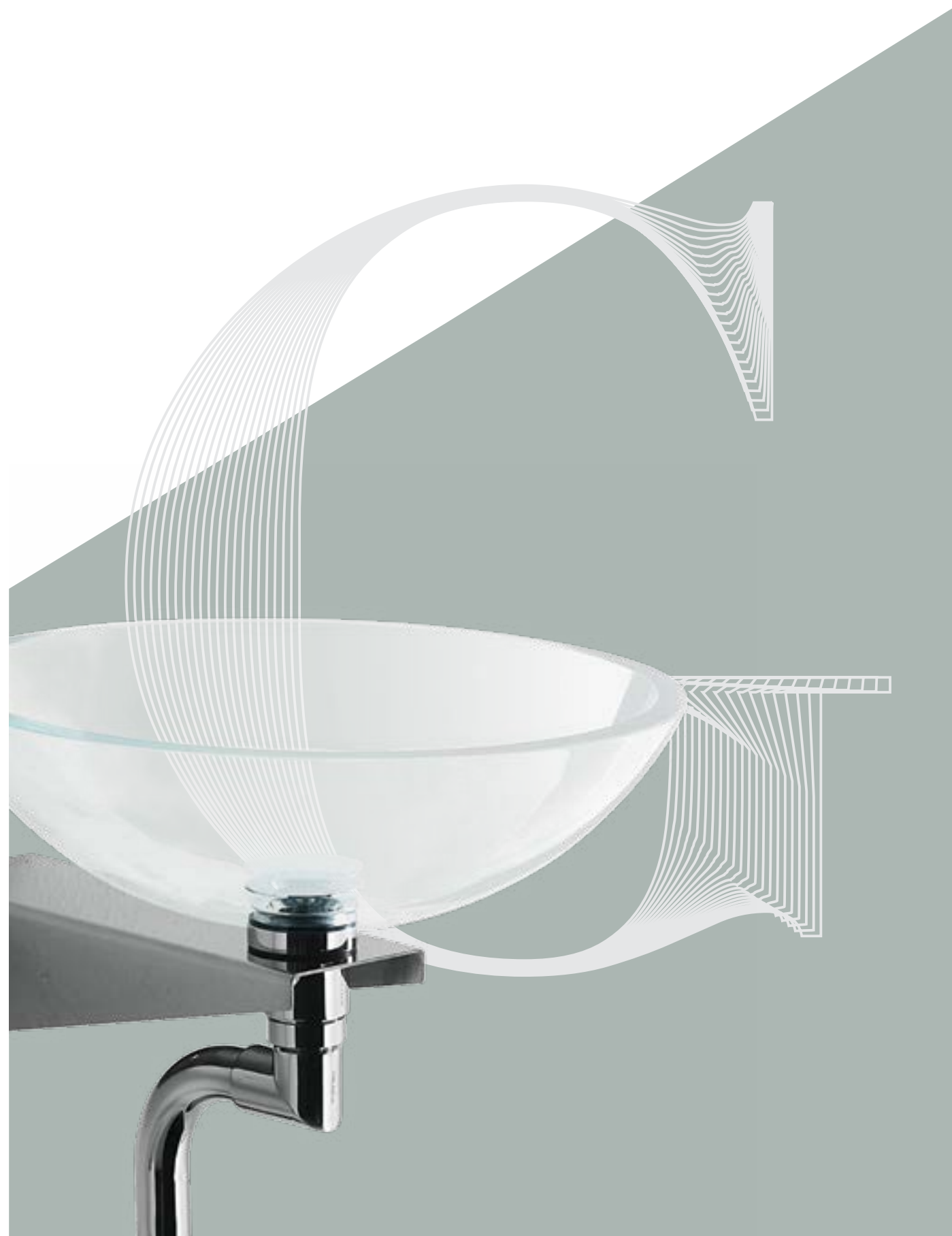

Bicchiere. Piano di appoggio per lavabo dalla forma essenziale realizzato con staffe in acciaio che consentono un solido fissaggio a muro.

EN~ *Glass. Holding set for glass or stainless steel washbasins realized with steel brackets that allow a solid wall fixing, ideal for small or public spaces.*

FR~ *Plan d'appui pour lavabo aux formes essentielles, fabriqué en matériau innovant Hanex AE blanc, avec supports en acier qui permettent une fixation murale solide.*

DE~ *Bodenabstützung für Körper vom wesentlichen Form realisiert in dem innovativen Material Hanex weißen AE mit Stahlklammern, die einer feste Befestigung an die Wand zu ermöglichen.*



Set supporto vasca con foro rubinetto, piletta Art. 53972 e sifone Art. 53921

Wall support, with tap hole with free waste water drain 53972, siphon 53921

Set support avec perçage de robinetterie, bonde à écoulement libre 53972, siphon 53921

Wandhalterung für Becken mit Hahnloch, Ablaufgarnitur 53972 und Siphon 53921

66201.29 → 84 ↑ 260 - 310 max ↗ 265

66211.29 → 104 ↑ 260 - 310 max ↗ 345



Set supporto vasca senza foro rubinetto, piletta Art. 53972 e sifone Art. 53921

Wall support, without tap hole with free waste water drain 53972, siphon 53921

Set support sans perçage de robinetterie, bonde à écoulement libre 53972, siphon 53921

Wandhalterung für Becken ohne Hahnloch, Ablaufgarnitur 53972 und Siphon 53921

66202.29 → 83 ↑ 170 - 220 max ↗ 235

66212.29 → 103 ↑ 170 - 220 max ↗ 325



Ciucci. Lavamani minuscolo e versatile che consente l'installazione anche in spazi ridottissimi. Realizzato in mattstone si accompagna a un supporto in acciaio verniciato o lucido.

EN~ *Pacifier. Minuscule and versatile mattstone washbasin that allows installation in small spaces. provided with a painted or polished stainless steel support.*

FR~ *Lave-main minuscule et polyvalent qui permet l'installation même dans des espaces très réduits. Fabriqué en pierre composite, il s'accompagne d'un support en acier verni ou brillant.*

DE~ *Handwaschbecken klein und vielseitig, die Installation in kleinen Räumen erlaubt. Hergestellt in mattstone, wird von einem lackierten oder polierten Stahlträger begleitet.*



6622 Lavamani con supporto, piletta scarico libero
Art. 53971, sifone Art. 53922

Handrinse basin with wall bearing, free waste water drain Art. 53971, siphon Art. 53922

Lave-mains, avec support, bonde à écoulement libre 53971, siphon 53922

Becken mit Halterung, freie Ablaufgarnitur 53971, Siphon 53922

→ 350 ↑ 235 - 323 max ↗ 315



Pozzanghera (Po-ciah). Lavabo rettangolare a muro in vetro temperato completo di foro laterale per miscelatore, incastonato in una struttura in acciaio inox con barra portasciugamani.

EN~ *Rectangular washbasin wall in full tempered glass lateral hole for mixer, embedded in a stainless steel structure that acts as a towel rail.*

FR~ *(Po-ciah) Flaque. Lavabo rectangulaire mural en verre trempé complet, avec trou latéral pour mitigeur, encastré dans une structure en acier inox avec barre porte-serviette.*

DE~ *(Po-ciah) Pfütze. Rechteckige Waschbecken für die Wand aus vollständig gehärtetem Glas, seitliches Loch für den Mischer, in einem Edelstahl-Gestell mit Handtuchhaltern eingebettet.*



665801.29.83 Lavamani in vetro con supporto, piletta scarico libero Art. 53971, sifone Art. 53922

Glass handrinse basin with wall bearing, free waste water drain Art. 53971, siphon Art. 53922

Lave-mains en verre avec bonde à écoulement libre 53971, siphon 53922

Becken aus Glas mit Ablaufgarnitur 53971 und Siphon 53922

→ 510 ↑ 295 - 415 max ↗ 355



Lavabo in ceramica disegnato nel 2015 da Fandesign studio. Ispirandosi alla nonna per la sua rigida inflessibilità nell'apparecchiare, questo lavabo replica la disposizione degli elementi: bicchiere/miscelatore in alto a destra, tovagliolo/portasalvietta a destra, pane/portasapone/troppopieno in alto a sinistra e piatto/lavabo al centro. Predisposto per il fissaggio a muro o da appoggio, possibilità di miscelatore a muro su richiesta.

EN~ *Etiquette. Ceramic washbasin designed by Fandesignstudio in 2015. Taking inspiration from their grandmother for her rigid approach to table etiquette, this washbasin replicates the proper arrangements for a formal dinner: right top glass/mixer, napkin/towel to the right, bread/soap dispenser/drain upper left and dish/basin in center. Available with wall fixing or countertop.*

FR~ *Lavabo en céramique conçu en 2015 par Fandesign studio. S'inspirant de l'inflexibilité de sa grand-mère pour mettre le couvert, ce lavabo reproduit la disposition des éléments : verre/mitigeur en haut à droite, nappe/porte-serviette à droite, pain/porte-savon/trop-plein en haut à gauche et assiette/lavabo au centre. Prédisposé pour la fixation murale ou pour être posé, possibilité de mitigeur au mur sur demande.*

DE~ *Waschbecken aus Keramik, im Jahr 2015 entworfen vom Studio Fandesign. Diese starre Ausrichtung stammt aus früheren Zeiten, und repliziert die Becken und die Anordnung der Elemente: Glas / Mischer in der oberen rechten Ecke, Serviette / Handtuchhalter rechts, Halter/Seife / Überlauf in der linken oberen Seite und Platte / Wanne in der Mitte. Vorbereitet für die Wand oder zum Anlehnen, Wand-Armatur auf Anfrage.*



.09 .17 .21 .26

53725 Lavabo in ceramica a muro o appoggio con troppopieno, completo di rubinetto, miscelatore, piletta e griglia portasapone

Ceramic wall or countertop washbasin with overflow, complete with faucet, mixer, click clack waste water drain and soap holder grid.

Lavabo en céramique à accrocher au mur ou à poser, avec trop-plein, robinetterie, bonde et grille pour savon

Keramikbecken Wandmontage oder Aufzusetzen mit Überlauf, Armatur, Ablaufgarnitur und Einlage für Seifenschale

→ 700 ↑ 450 ↗ 145



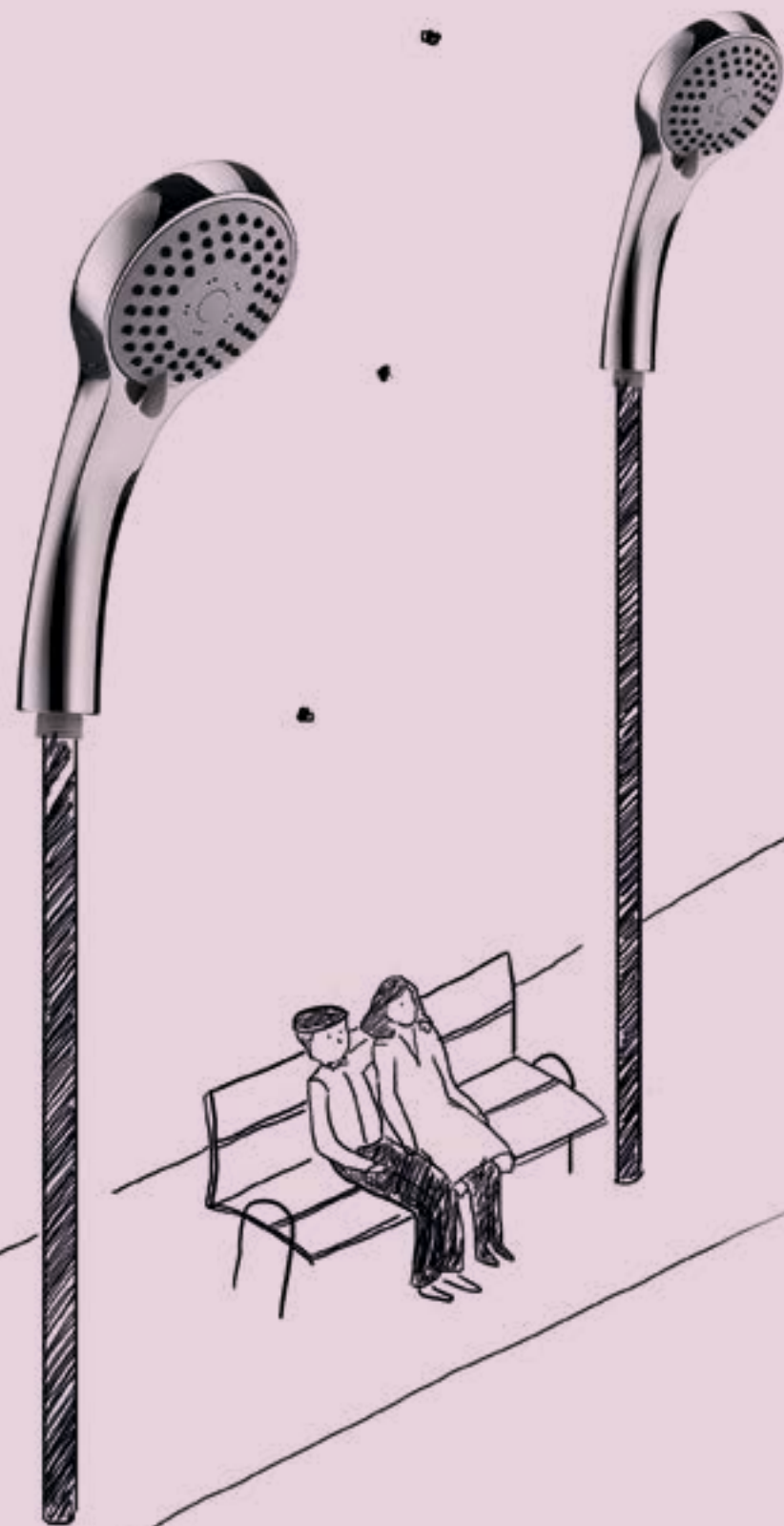

Collezione Doccia
Shower Collection
Collection Douche
Kollektion Dusche

ISTÀ	Doccia da esterni / Outdoor shower / Douche pour usage externe / Aussendusche	325
SUPIONI	Soffioni doccia / Shower heads / Pommes de douche / Kopfbrause	329
LINEA DOCCIA	Supporti doccia / Shower supports / Supports pour douche / Halter für Dusche	343
FILO	Griglie doccia / Shower grids / Paniers douche / Duschkörbe	351
ATLANTICA	Pedane doccia / Shower mats / Caillebotis / Duschfußbrett	357
KIT TAKE AWAY	Accessori in kit / Accessories kit / Kit d'accessoires / Kit von Zubehör	359



Estate. Doccia da esterni mobile, che come l'estate viene riposta per poi ritornare. Estremamente leggera, perfetta per ambienti outdoor stagionali, disegnata da Studio JoeVelluto nel 2013.

EN~ *Summer. Outdoor movable shower that like summer come and go. Very light and perfect for seasonal outdoor use. Designed by JoeVelluto studio in 2013.*

FR~ *Douche extérieure mobile, installée quand vient l'été, pour ensuite rentrer. Extrêmement légère, parfaite pour des milieux extérieurs de saison, conçue par Studio JoeVelluto en 2013.*

DE~ *Mobile Außendusche, die im Sommer aufgestellt und dann wieder eingeklappt werden kann. Extrem leicht, ideal für saisonale Outdoor-Umgebung, im Jahr 2013 entworfen vom Studio JoeVelluto.*



53830.09.20 Doccia da esterni mobile con base in polietilene, staffa e soffione in metallo verniciato a polveri

Outdoor movable shower. Polyethylene base, dust painted metal tubular and shower head

Douche mobile pour usage externe, base en polyéthylène, colonne et pomme de douche en acier vernis à poudre

Aussendusche beweglich mit Fuß aus Polyäthylen, Kolumn und Duschkopf aus lackiertem Edelmetall

→ 880 ↑ 2300 ↗ 880





SUPIONI

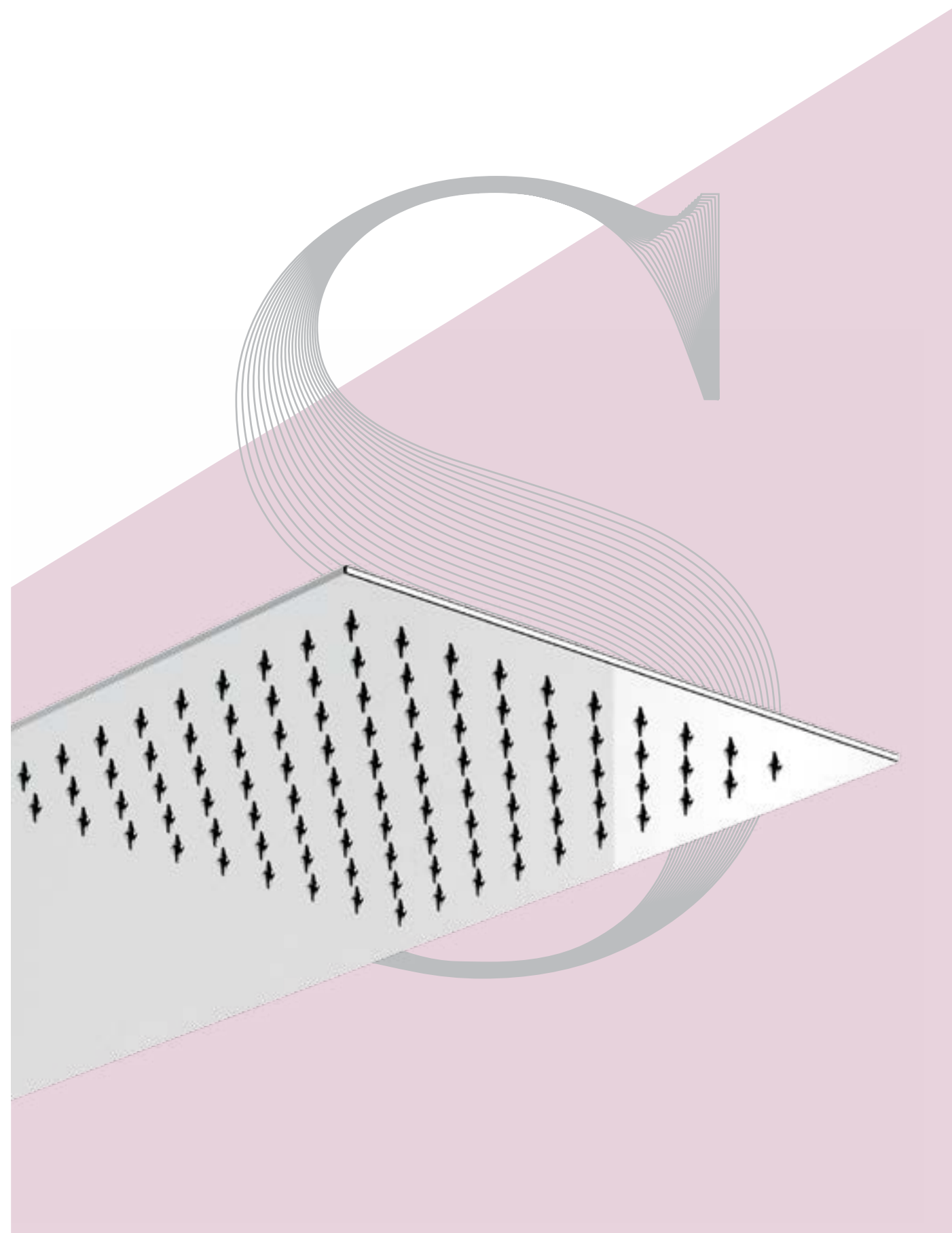

Soffiatori. Avvolgenti getti di benessere dalla collezione di grandi soffioni per doccia.

Disponibili diverse dimensioni e forme, dai classici modelli in ottone cromato a quelli elettrosaldati in acciaio inox.

EN~ *Blowers. Enveloping shots of wellness form the collection of big shower heads. Multiple sizes and dimensions are available, from the classic chromed brass models to the electro welded stainless steel ones.*

FR~ *Jets enveloppants de bien-être de la collection des grands pommeaux de douche. Disponibles en diverses dimensions et formes, des modèles classiques en laiton chromé à ceux électrosoudés en acier inox.*

DE~ *Strahlen aus einer Kollektion von Duschköpfen für Ihr Wohlbefinden. Erhältlich in verschiedenen Größen und Formen, von klassisch verchromten Messingmodellen bis zu verschweißtem Edelstahl.*

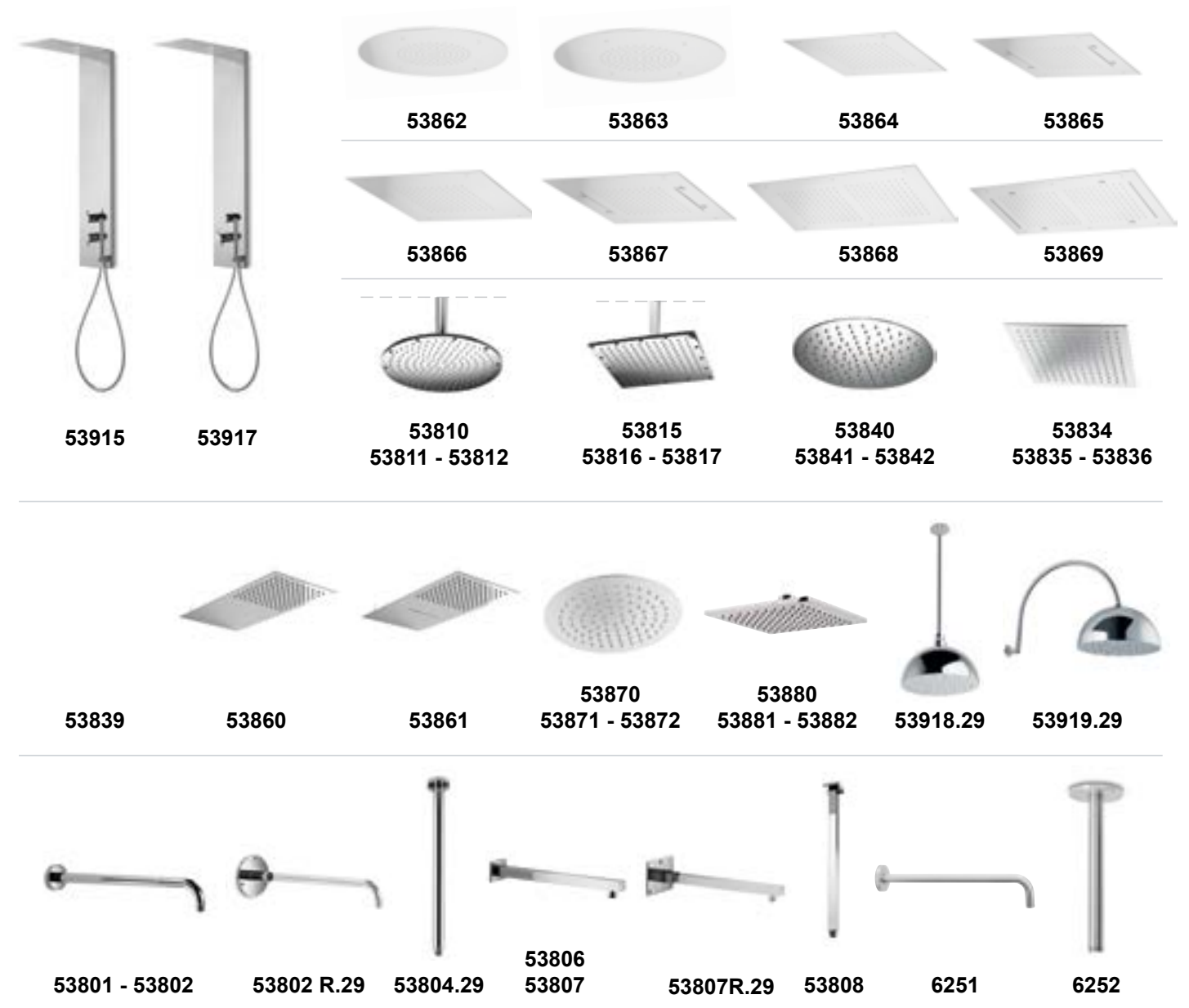

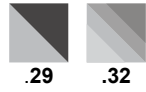

53915

Colonna doccia completa con miscelatore e doccetta in acciaio inox

Shower column complete with mixer and handshower in stainless steel

Colonne de douche avec mitigeur et douchette acier inox

Duschsäule aus Edelstahl mit Mischer und Handbrause

→ 200 ↑ 1108 ↗ 500

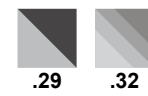

53917

Colonna doccia completa con miscelatore termostatico e doccetta in acciaio inox

Shower column with thermostatic mixer and handshower in stainless steel

Colonne de douche avec mitigeur thermostatique et douchette acier inox

Duschsäule aus Edelstahl mit Thermostat-Mischer und Handbrause

→ 200 ↑ 1108 ↗ 500

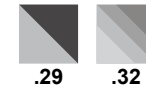

53862

Soffione a soffitto tondo Ø 400 mm acciaio inox solo pioggia

Built-In round Ø 400 mm shower head, made of stainless steel, rain

Pomme de douche de plafond ronde Ø 400 mm pluie, acier inox

Kopfbrause runde am Decken Ø 400 mm aus Edelstahl nur Regen

Ø 400



BAR PRESSURE	2	3	4
PIOGGIA / RAIN	10 lt/min	12,6 lt/min	13 lt/min

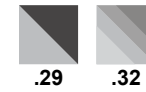

53863

Soffione a soffitto tondo Ø 550 mm acciaio inox solo pioggia

Built-In round Ø 550 mm shower head, made of stainless steel, rain

Pomme de douche de plafond ronde Ø 550 mm pluie, acier inox

Kopfbrause runde am Decken Ø 550 mm aus Edelstahl nur Regen

Ø 550



BAR PRESSURE	2	3	4
PIOGGIA / RAIN	10,7 lt/min	13,2 lt/min	14,2 lt/min

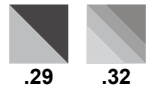

53864 Soffione a soffitto quadro 430 x 430 mm acciaio inox solo pioggia

Built-in square 430 x 430 mm shower head made of stainless steel, rain

Pomme de douche de plafond carrée 430 x 430 mm pluie, acier inox

Kopfbrause quadratisch am Decken 430 x 430 mm aus Edelstahl nur Regen

→ 430 ↗ 430



BAR PRESSURE	2	3	4
PIOGGIA / RAIN	10,1 lt/min	13,3 lt/min	15,1 lt/min

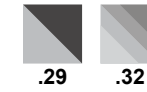

53866 Soffione a soffitto quadro 500 x 500 mm acciaio inox solo pioggia

Built-in square 500 x 500 mm shower head made of stainless steel, rain

Pomme de douche de plafond carrée 500 x 500 mm pluie, acier inox

Kopfbrause quadratisch am Decken 500 x 500 mm aus Edelstahl nur Regen

→ 500 ↗ 500



BAR PRESSURE	2	3	4
PIOGGIA / RAIN	10,2 lt/min	13,1 lt/min	13,3 lt/min

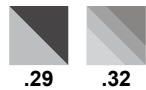

53865 Soffione a soffitto quadro 430 x 430 mm acciaio inox, pioggia, 4 nebulizzatori, 2 cascate

Built-in square 430 x 430 mm shower head made of stainless steel, rain, 4 nebulizers, 2 waterfall

Pomme de douche de plafond carrée 430 x 430 mm, pluie, 4 brumisateurs, 2 cascades, acier inox

Kopfbrause quadratisch am Decken 430 x 430 mm aus Edelstahl, Regen, 4 Nebeldüsen, 2 Wasserfälle

→ 430 ↗ 430



BAR PRESSURE	2	3	4
PIOGGIA / RAIN	10,1 lt/min	13,3 lt/min	15,1 lt/min
CASCATA / WATERFALL	16,2 lt/min	22,2 lt/min	26,9 lt/min
NEBULIZZATORI / NEBULIZERS	6,1 lt/min	7,8 lt/min	9,6 lt/min

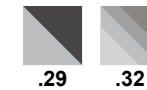

53867 Soffione a soffitto quadro 500 x 500 mm acciaio inox, pioggia, 4 nebulizzatori, 2 cascate

Built-in square 500 x 500 mm shower head made of stainless steel, rain, 4 nebulizers, 2 waterfall

Pomme de douche de plafond carrée 500 x 500 mm, pluie, 4 brumisateurs, 2 cascades, acier inox

Kopfbrause quadratisch am Decken 500 x 500 mm aus Edelstahl, Regen, 4 Nebeldüsen, 2 Wasserfälle

→ 500 ↗ 500



BAR PRESSURE	2	3	4
PIOGGIA / RAIN	10,1 lt/min	13,3 lt/min	15,1 lt/min
CASCATA / WATERFALL	16,2 lt/min	22,2 lt/min	26,9 lt/min
NEBULIZZATORI / NEBULIZERS	6,1 lt/min	7,8 lt/min	9,6 lt/min

ATTENZIONE: abbinare a deviatore con almeno 3 vie

ATTENTION: combine with at least a 3 outlets diverter

ATTENTION: assembler avec inverseur avec au moins 3 sorties

ACTUNG: Kombinieren Mindestens Mit Umsteller Dreibege

ATTENZIONE: abbinare a deviatore con almeno 3 vie

ATTENTION: combine with at least a 3 outlets diverter

ATTENTION: assembler avec inverseur avec au moins 3 sorties

ACTUNG: Kombinieren Mindestens Mit Umsteller Dreibege

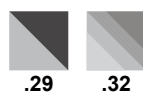

53868

Soffione a soffitto quadro 700 x 400 mm acciaio inox solo pioggia

Built-in square 700 x 400 mm shower head made of stainless steel, rain

Pomme de douche de plafond carrée 700 x 400 mm pluie, acier inox

Kopfbrause quadratisch am Decken 700 x 400 mm aus Edelstahl nur Regen

→ 400 ↗ 700



BAR PRESSURE	2	3	4
PIOGGIA / RAIN	10,7 lt/min	14,1 lt/min	16 lt/min

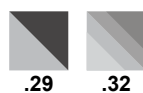

53869

Soffione a soffitto quadro 700 x 400 mm acciaio inox, pioggia, 4 nebulizzatori, 2 cascate

Built-in square 700 x 400 mm shower head made of stainless steel, rain, 4 nebulizers, 2 waterfall

Pomme de douche de plafond carrée 700 x 400 mm, pluie, 4 brumisateurs, 2 cascades, acier inox

Kopfbrause quadratisch am Decken 700 x 400 mm aus Edelstahl, Regen, 4 Nebeldüsen, 2 Wasserfälle

→ 400 ↗ 700



BAR PRESSURE	2	3	4
PIOGGIA / RAIN	10,7 lt/min	14,1 lt/min	16 lt/min
CASCATA / WATERFALL	16,2 lt/min	22,2 lt/min	26,9 lt/min
NEBULIZZATORI / NEBULIZERS	6,1 lt/min	7,8 lt/min	9,6 lt/min

ATTENZIONE: abbinare a deviatore con almeno 3 vie
 ATTENTION: combine with at least a 3 outlets diverter
 ATTENTION: assembler avec inverseur avec au moins 3 sorties
 ACTUNG: Kombinieren Mindestens Mit Umsteller Dreiweg

Soffione doccia ispezionabile con snodo 1/2"

Self-cleaning shower head, with 1/2" connection

Pomme de douche autonettayante avec raccord 1/2"

Selbstreinigender Kopfbrause mit Kugelgelenk G 1/2"

53810.29 Ø 180 ↑ 69

53811.29 Ø 230 ↑ 69

53812.29 Ø 300 ↑ 69

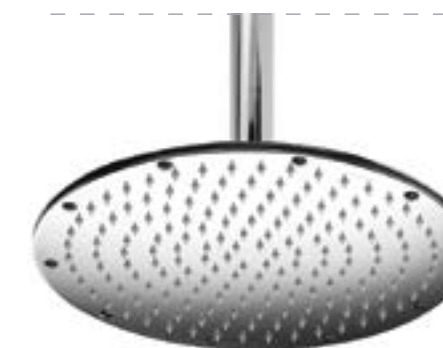
Soffione doccia ispezionabile con snodo 1/2"

Self-cleaning shower head, with 1/2" connection

Pomme de douche autonettayante avec raccord 1/2"

Selbstreinigender Kopfbrause mit Kugelgelenk G 1/2"

53815.29 → 180 ↑ 69 ↗ 180

53816.29 → 230 ↑ 69 ↗ 230

53817.29 → 300 ↑ 69 ↗ 300

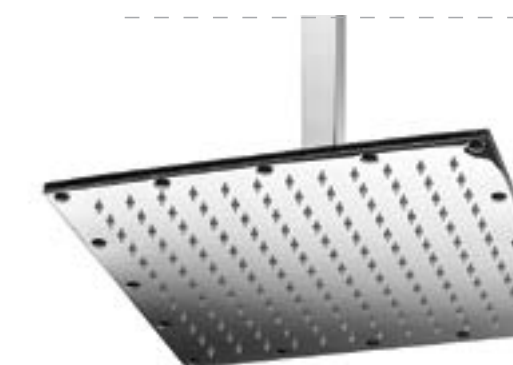
Soffione doccia tondo acciaio inox piatto

Round flat shower head stainless steel

Pomme de douche ronde plate en acier inox

Duschkopf flach rund aus Edelstahl

53840.29 Ø 200 ↑ 66

53841.29 Ø 250 ↑ 66

53842.29 Ø 300 ↑ 66

Soffione doccia quadro acciaio inox piatto

Square flat shower head stainless steel

Pomme de douche carrée plate en acier inox

Duschkopf flach quadratisch aus Edelstahl

53834.29 → 200 ↑ 63 ↗ 200

53835.29 → 250 ↑ 63 ↗ 250

53836.29 → 300 ↑ 63 ↗ 300



53839.29 Soffione doccia rettangolare acciaio inox piatto

Rectangular flat shower head stainless steel
Pomme de douche rectangulaire plate en acier inox
Duschkopf flach rechteckiger aus Edelstahl

→ 180 ↑ 63 ↗ 250

**Soffione doccia rettangolare acciaio inox piatto**

Rectangular flat shower head stainless steel
Pomme de douche rectangulaire plate en acier inox
Duschkopf flach rechteckiger aus Edelstahl

53860.29 → 500 ↑ 53 ↗ 250

**53861.29 Soffione doccia rettangolare acciaio inox piatto con cascata**

Rectangular flat shower head stainless steel with waterfall

Pomme de douche rectangulaire plate en acier inox avec cascade

Duschkopf flach rechteckiger aus Edelstahl mit Wasserfallfunktion

→ 500 ↑ 53 ↗ 250

**Soffione doccia tondo spessorato 7 mm**

Thickened round shower head 7 mm
Pomme de douche ronde épaisseur 7 mm
Duschkopf rund Dicke 7 mm

53870.29 Ø 200 ↑ 70

53871.29 Ø 250 ↑ 70

53872.29 Ø 300 ↑ 70

**Soffione doccia quadro spessorato 7 mm**

Thickened square shower head 7 mm
Pomme de douche carré épaisseur 7 mm
Duschkopf quadratisch Dicke 7 mm

53880.29 → 200 ↑ 55 ↗ 200

53881.29 → 250 ↑ 55 ↗ 250

53882.29 → 300 ↑ 55 ↗ 300



53918.29 Soffione doccia a campana con braccio a soffitto*Bell shaped shower head with ceiling arm**Pomme de douche avec bras de plafond**Duschkopf/Deckelarm glockenförmig*

Ø 200 ↑ 525

**Braccio doccia tondo a parete per snodo 1/2"***Wall round shower-arm, 1/2" joint**Bras de douche mural, rond, raccord 1/2"**Brausearm, Wandmontage G 1/2" rund***53801.29** → 62 ↑ 100 ↗ 320**53802.29** → 62 ↑ 100 ↗ 420**53802R.29** Rinforzo per braccio tondo*Round sure grip shower-arm flange**Bras de douche mural, rond, raccord 1/2"**Verstärkung für Brausearm rund*

Ø 120 ↑ 63

**53919.29** Soffione doccia a campana con braccio a parete*Bell shaped shower head with wall arm**Pomme de douche avec bras mural**Duschkopf/Wandarm glockenförmig*

Ø 200 ↑ 490

**53804.29** Braccio doccia a soffitto, tondo, per snodo 1/2"*Ceiling round shower-arm, 1/2" joint**Bras de douche de plafond, rond, raccord 1/2"**Brausearm, Deckenmontage G 1/2" rund*

Ø 62 ↑ 250



Braccio doccia quadro a parete, per snodo 1/2"*Wall square shower-arm, 1/2" joint**Bras de douche mural, carré, raccord 1/2"**Brausearm, Wandmontage G 1/2" quadratisch*

53806.29 → 55 ↑ 55 ↗ 320

53807.29 → 55 ↑ 55 ↗ 420

**53807R.29 Rinforzo per braccio doccia quadro a parete, per snodo 1/2"***Square sure grip shower-arm flange 1/2" joint**Plaque de support pour bras de douche carré raccord 1/2"**Verstärkung für Brausearm quadratisch Wandmontage G 1/2"*

→ 100 ↑ 100 ↗ 63

**53808.29 Braccio doccia a soffitto, quadro, per snodo 1/2"***Ceiling square shower-arm, 1/2" joint**Bras de douche de plafond, carré, raccord 1/2"**Brausearm Deckenmontage G 1/2" quadratisch*

→ 55 ↑ 55 ↗ 250

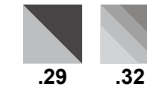
**6251 Braccio doccia in acciaio inox a parete 300 mm***Wall shower-arm 300 mm in stainless steel**Bras de douche mural 300 mm en acier inox**Brausearm Wandmontage 300 mm aus Edestahl*

Ø 20 ↗ 350

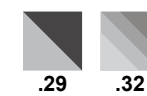
**6252 Braccio doccia in acciaio inox a soffitto 200 mm***Ceiling shower-arm 200 mm in stainless steel**Bras de douche de plafond 200 mm en acier inox**Brausearm Deckenmontage 200 mm aus Edestahl*

Ø 20 ↗ 200





Aste saliscendi, colonne per doccia in ottone cromato, attrezzabili liberamente con flessibili e doccette.

Linea completata ed arricchita dalla presenza di oggetti per ripararsi dagli spruzzi della doccia: tenda in cotone waterproof, ganci e barre in ottone cromato. Notevoli i nuovi puliscivetro.

EN~ *Ups and downs, freely customizable chromed brass shower columns with shower sprouts: this collection is everything you need for your shower. From waterproof cotton curtains to chromed brass hooks and bars. Considerable new glass wiper.*

FR~ *Poignées va-et-vient, colonnes pour douche en laiton chromé, pouvant être librement équipé avec flexibles et douchettes. Ligne complète et enrichie par la présence d'objets pour se couvrir des éclaboussures de la douche : rideau en coton waterproof, poignées et barres en laiton chromé, raclettes de douche.*

DE~ *Höhen und Tiefen, Säulen aus Messing für verchromt Dusche, kann frei mit flexiblen Handbrausen ausgestattet werden. Eine Linie, die abgeschlossen und bereichert wurde durch die Anwesenheit von Objekten zum Schutz der Duschbrause: Baumwolle wasserdicht, Haken und Stangen aus verchromtem Messing. Beträchtlich sind die neue Scheibenwischer.*



53290



53289



53288



541713



541721



541712



541723



541714



54180



54174



54175



71801



541701



541702



71802



71804



71805

53290.17 Puliscivetro acciaio/silicone

Glass wiper / stainless steel / silycon

Raclette de douche, acier et silicone

Scheibenwischer

→ 260 ↑ 215 ↗ 30



53289.17 Puliscivetro per parete e pavimento

Adjustable glass wiper 1 mt / wall and floor

Raclette de douche 1 mt démontable

Scheibenwischer für Wand und Boden

→ 370 ↑ 1260 ↗ 16



53288.17 Puliscivetro in silicone

Silicon glass wiper

Raclette de douche en silicone

Scheibenwischer aus Silikon

→ 242 ↑ 200 ↗ 60



541713.29 Doccetta cilindrica cromo

Round hand shower chrome

Douchette cylindrique chrome

Handbrause rund Chrom

Ø 26 ↑ 186



541721.29 Doccetta, 3 getti regolabili

Hand shower with 3 jets

Douchette massage avec 3 jets

Handbrause 3 Strahlarten

→ 100 ↑ 220

541712.29 Doccetta quadrata cromo

Square hand shower chrome

Douchette carrée chrome

Handbrause quadratisch Chrom

→ 29 ↑ 186 ↗ 16



541723.29.09 Doccetta

Hand shower

Douchette

Handbrause

→ 103 ↑ 245

541714.29 Supporto a muro per doccetta cromo

Hand shower support chrome

Support pour douchette chrome

Wandhalter für Handbrause Chrom

Ø 34 ↗ 44



541701.29 Flessibile doppia maglia 1500 mm, con attacco conico da 1/2"

Double seam flexible hose 1500 mm, with 1/2" connection

Flexible 1500 mm, raccord G 1/2"

Brausenschlauch 1500 mm, konische Mutter G 1/2"

→ 1500



541702.29 Flessibile PVC 1500 mm, con attacco conico da 1/2"

PVC flexible hose 1500 mm, with 1/2" connection

Flexible PVC 1500 mm, raccord G 1/2"

Brausenschlauch aus PVC 1500 mm, konische Mutter G 1/2"

→ 1500



54180.29 Colonna doccia con deviatore, flessibile, doccetta cilindrica, altezza regolabile

Equipped shower column with diverter and hose, hand shower, adjustable height

Colonne de douche avec inverseur, flexible, douchette, hauteur réglable

Brausestange mit Umsteller, Schlauch, Handbrause und höhenverstellbar

→ 100 ↑ 1200 - 1400 ↗ 425



54174.29 Asta saliscendi tubo tondo

Round sliding rail

Barre de douche ronde

Runde Brausestange

→ 100 ↑ 840 ↗ 60



54175.29 Asta saliscendi tubo rettangolare

Square sliding rail

Barre de douche rectangulaire

Rechteckige Brausestange

→ 220 ↑ 740 ↗ 90

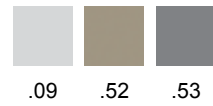

71801 Tenda doccia waterproof

Waterproof shower curtain
Rideau de douche imperméable
Duschvorhang wasserdicht

→ 1800 ↑ 2000



71802.29 Set 12 ganci tenda

12 shower curtain hooks
Anneaux pour rideau de douche (12 pièces)
Ringe 12Stk für Duschvorhang

→ 40 ↑ 68



71804.29 Tubo per doccia ad angolo (accorciabile)

Corner shower curtain holder (can be shortened)
Support angle pour rideau de douche (on peut raccourcir)
Eckige Halterung für Duschvorhang (verkürzbar)

→ 1007 ↑ 80 ↗ 1007



71805.29 Tubo per doccia dritto (accorciabile)

Straight shower curtain holder (can be shortened)
Support droit pour rideau de douche (on peut raccourcir)
Halterung für Duschvorhang (verkürzbar)

→ 1770 ↑ 80 Ø 25

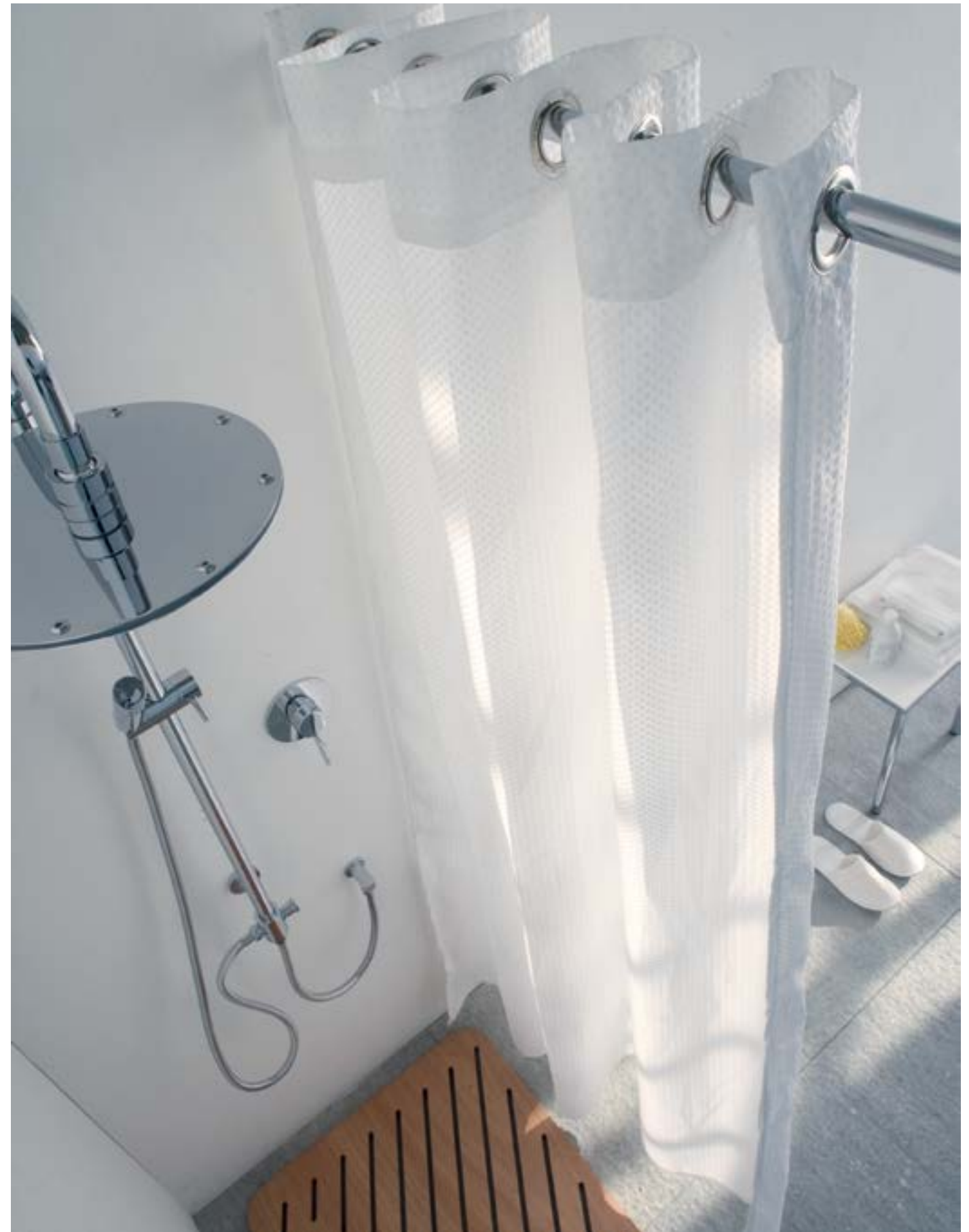

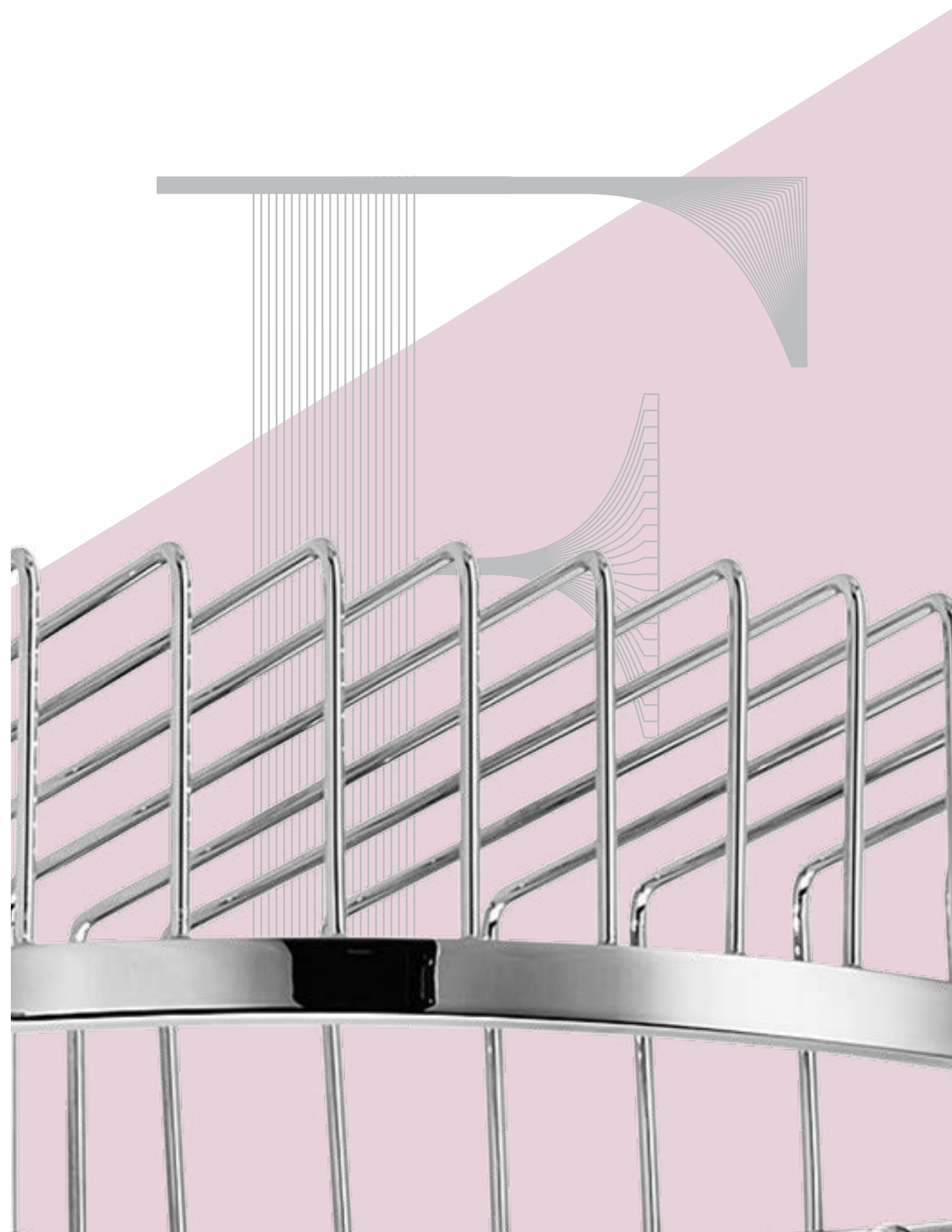

Pratice griglie portaoggetti a muro o da appoggio per la doccia che sposano eleganza e praticità angolari o rettangolari, di diverse dimensioni, in ottone cromato e acciaio inox.

EN~ *String. Practical wall shower grids that link elegance and practicality. Available in different shapes and dimensions, all made of chromed brass and stainless steel.*

FR~ *Grilles porte-objets pratiques murales ou à poser pour la douche, qui marient élégance et praticité, angulaire ou rectangulaire, de diverses dimensions, en laiton chromé et acier inox.*

DE~ *Praktische Lagerregale für die Wand oder als Einbau in der Dusche, die Eleganz und praktischen Nutzen verbinden; es gibt sie in unterschiedlicher Größe, aus Messing verchromt und Edelstahl.*

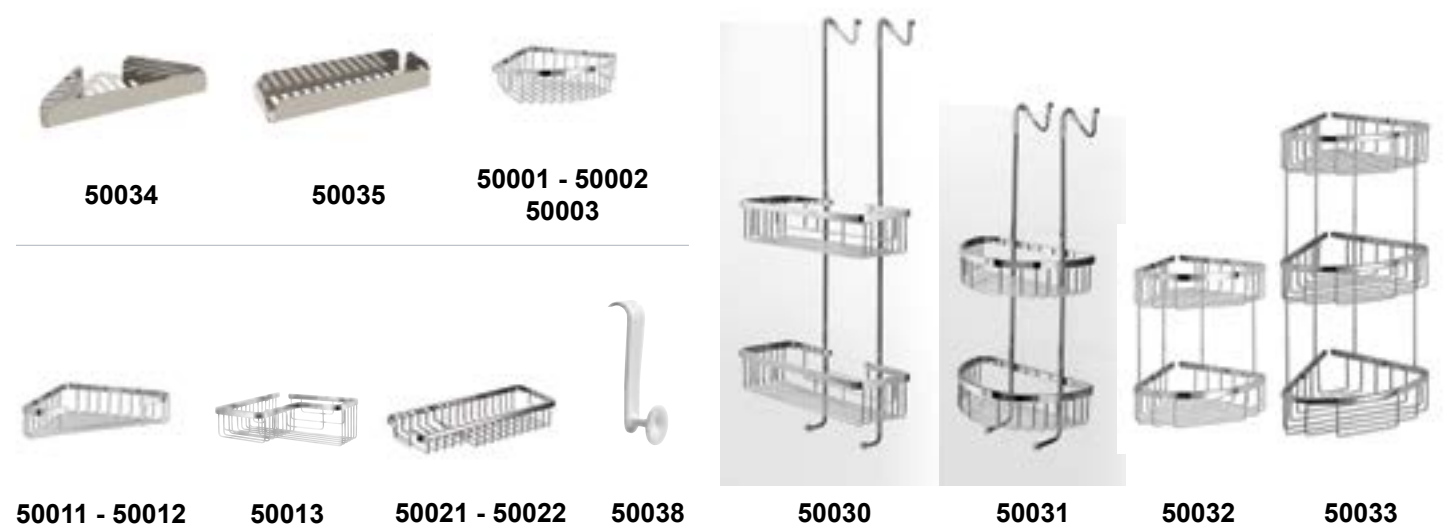

50034.29 Griglia doccia angolare in acciaio

Steel corner shower basket

Panier douche angulaire en acier

Seifenablage eckig aus Edelstahl

→ 279 ↑ 40 ↗ 143



50035.29 Griglia doccia in acciaio

Steel shower basket

Panier douche en acier

Seifenablage aus Edelstahl

→ 300 ↑ 40 ↗ 100



Griglia doccia angolare

Corner shower basket

Panier douche angulaire

Seifenablage eckig

50001.29 → 198 ↑ 70 ↗ 160

50002.29 → 250 ↑ 70 ↗ 198

50003.29 → 297 ↑ 70 ↗ 238



Griglia doccia angolare

Corner shower basket

Panier douche angulaire

Seifenablage eckig

50011.29 → 245 ↑ 60 ↗ 150

50012.29 → 325 ↑ 60 ↗ 190



50013.29 Griglia doccia angolare

Corner shower basket

Panier douche angulaire

Seifenablage eckig

→ 205 ↑ 87 ↗ 265

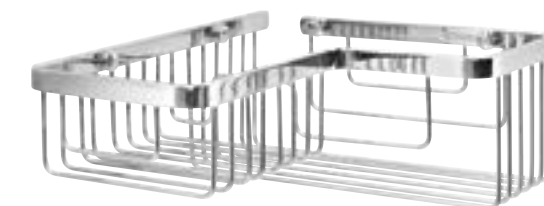

Portaoggetti da doccia

Basket for shower

Panier porte-objets pour douche

Schwammkorb für Dusche

50021.29 → 290 ↑ 55 ↗ 140

50022.29 → 400 ↑ 60 ↗ 140



50030.29 Griglia doccia doppia, da appendere

Hanging double shower basket
Panier angulaire double pour douche
Duschablage zum Hängen 2-fach
 → **300** ↑ **680** ↗ **210**



50031.29 Griglia doccia doppia, da appendere

Hanging double shower basket
Panier angulaire double pour douche
Duschablage zum Hängen 2-fach
 → **250** ↑ **550** ↗ **220**



50032.29 Griglia doccia angolare doppia

Corner shower basket, double
Panier angulaire double pour douche
Duschablage 2-fach
 → **270** ↑ **288** ↗ **205**



50033.29 Griglia doccia angolare tripla

Corner shower basket, triple
Panier angulaire triple pour douche
Duschablage 3-fach
 → **270** ↑ **510** ↗ **205**



50038.09 Appendini per termoarredo (12 pezzi)

Hooks for radiators (12 pieces)
Patère pour radiateur (12 pièces)
Haken für Heizkörper (12 Stk)
 → **40** ↑ **140** ↗ **60**



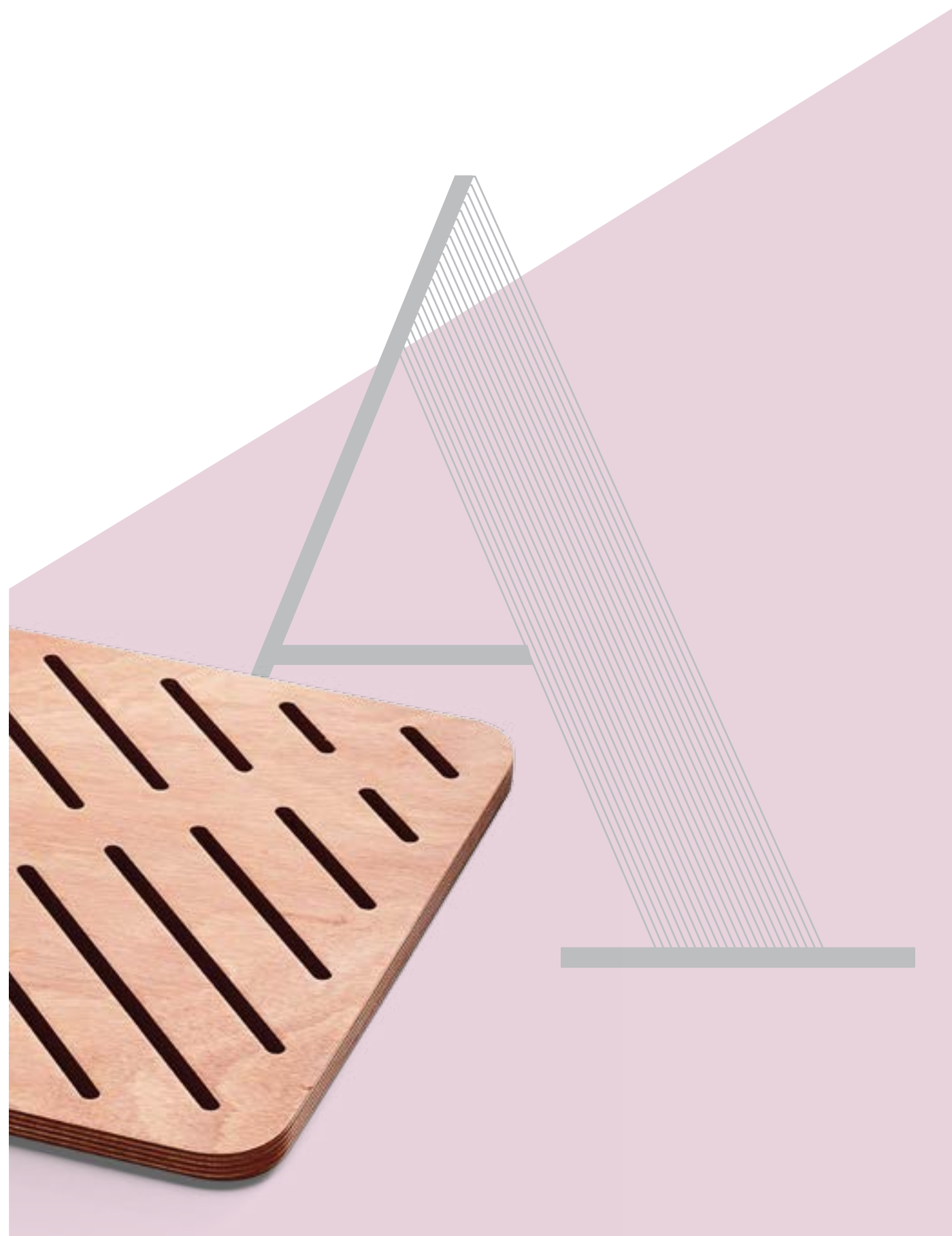

Serie di pedane indoor e outdoor, squadrate o angolari, realizzate in pregiato multistrato marino. Disponibili forme e misure customizzate a seconda delle richieste. Possibilità di customizzazione con intaglio su legno. Finitura naturale con oliatura superficiale.

EN~ *Outdoor and indoor shower mats, made of selected marine plywood. Available with customized shapes and measurements upon requests. Possibility of selecting overlay engraving. Natural finishing with superficial oiling.*

FR~ *Série de caillebotis intérieurs et extérieurs, rectangulaires ou angulaires, fabriqués en contreplaqué marin précieux. Disponibles en formes et tailles personnalisables selon les demandes. Possibilité de personnaliser avec entaille sur le bois. Finition naturelle avec huilage de surface.*

DE~ *Serie von Innen- und Außenterrassen, quadratisch oder eckig, hergestellt aus hochwertigem Multiplex-Holz. Erhältlich in maßgeschneiderte Formen und Größen je nach Wünschen. Möglichkeit der Anpassung von Holz-Einarbeitungen. Natürliche Oberfläche mit Oberflächen-Ölung.*

Pedana doccia in multistrato marino

Marine plywood shower mat

Caillebotis douche en bois multicouche marin

Duschfußbrett aus marine Sperrholz

7224.08	→	500	↑	20	↗	500
7225.08	→	540	↑	20	↗	540
7226.08	→	600	↑	20	↗	600
7227.08	→	640	↑	20	↗	640
72271.08	→	740	↑	20	↗	740
7228.08	→	740	↑	20	↗	540
7229.08	→	1000	↑	20	↗	600



7230.08 Pedana doccia in multistrato marino

Marine plywood shower mat

Caillebotis douche en bois multicouche marin

Duschfußbrett aus marine Sperrholz

→	640	↑	20	↗	640
---	------------	---	-----------	---	------------



KIT TAKE AWAY

Kit disponibili a catalogo di prodotti che consentono di avere tutto quello che serve per la doccia.

EN~ *Our Take Away Kit grants to have everything you need to accessorize the shower.*

FR~ *Les kits disponibles sur catalogue produits permettent d'avoir tout le nécessaire pour la douche.*

DE~ *Die verfügbaren Kits erlauben Ihnen alles, was Sie zum Duschen haben müssen.*

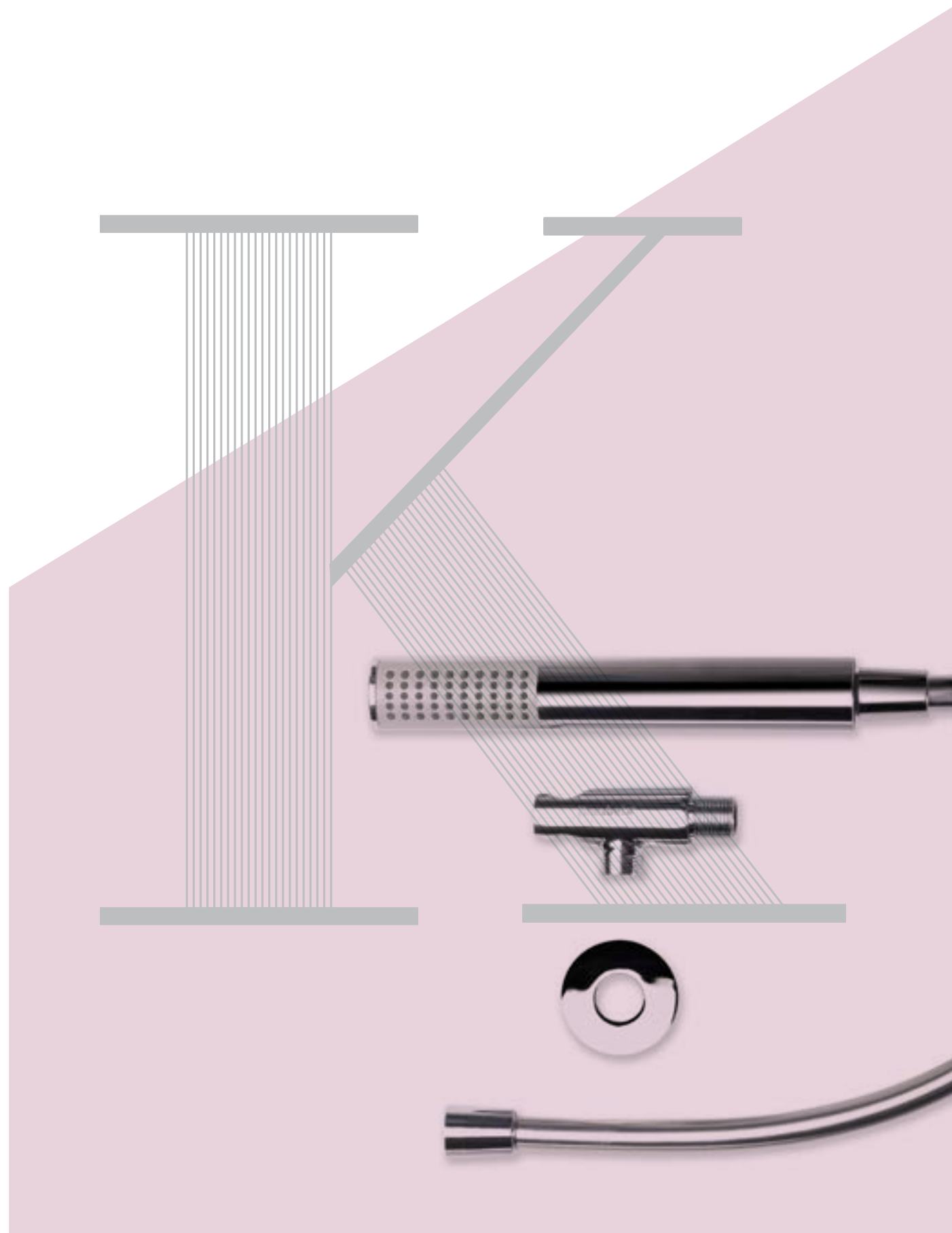

TA-DOCCIAT



TA-DOCCIAQ



TA-DOCCIAT MAXI 1



TA-DOCCIAT MAXI 2



TA-DOCCIAQ MAXI 1



TA-DOCCIAQ MAXI 2

DOCCIA BASE kit



TA-DOCCIAT

541713.29 / 541702.29 / 54198.29

DOCCIA BASE kit



TA-DOCCIAQ

541712.29 / 541702.29 / 54199.29

DOCCIA MAXI kit



TA-DOCCIAT MAXI 1

53840.29 (Ø 200 mm) / 53801.29 / 541702.29 / 541713.29 / 54198.29

DOCCIA MAXI kit



TA-DOCCIAT MAXI 2

53841.29 (Ø 250 mm) / 53801.29 / 541702.29 / 541713.29 / 54198.29

DOCCIA MAXI kit



TA-DOCCIAQ MAXI 1

53835.29 (250x250 mm) / 53806.29 / 541702.29 / 541712.29 / 54199.29

DOCCIA MAXI kit



TA-DOCCIAQ MAXI 2

53834.29 (200x200 mm) / 53806.29 / 541702.29 / 541712.29 / 54199.29



Collezione Scopini
Toilet brush holders Collection
Collection Porte-balais
Kollektion We Bürste

BASTON	Scopini ceramica e silicone / <i>Silicon and ceramic Toilet brush holders / Porte-balais en céramique et silicone / Wc Bürstengarnitur aus Silikon und Keramik</i>	369
SKOATI	Scopini metallo / <i>Metal Toilet brush holders / Porte-balais en métal / Wc Bürstengarnitur aus Metall</i>	373

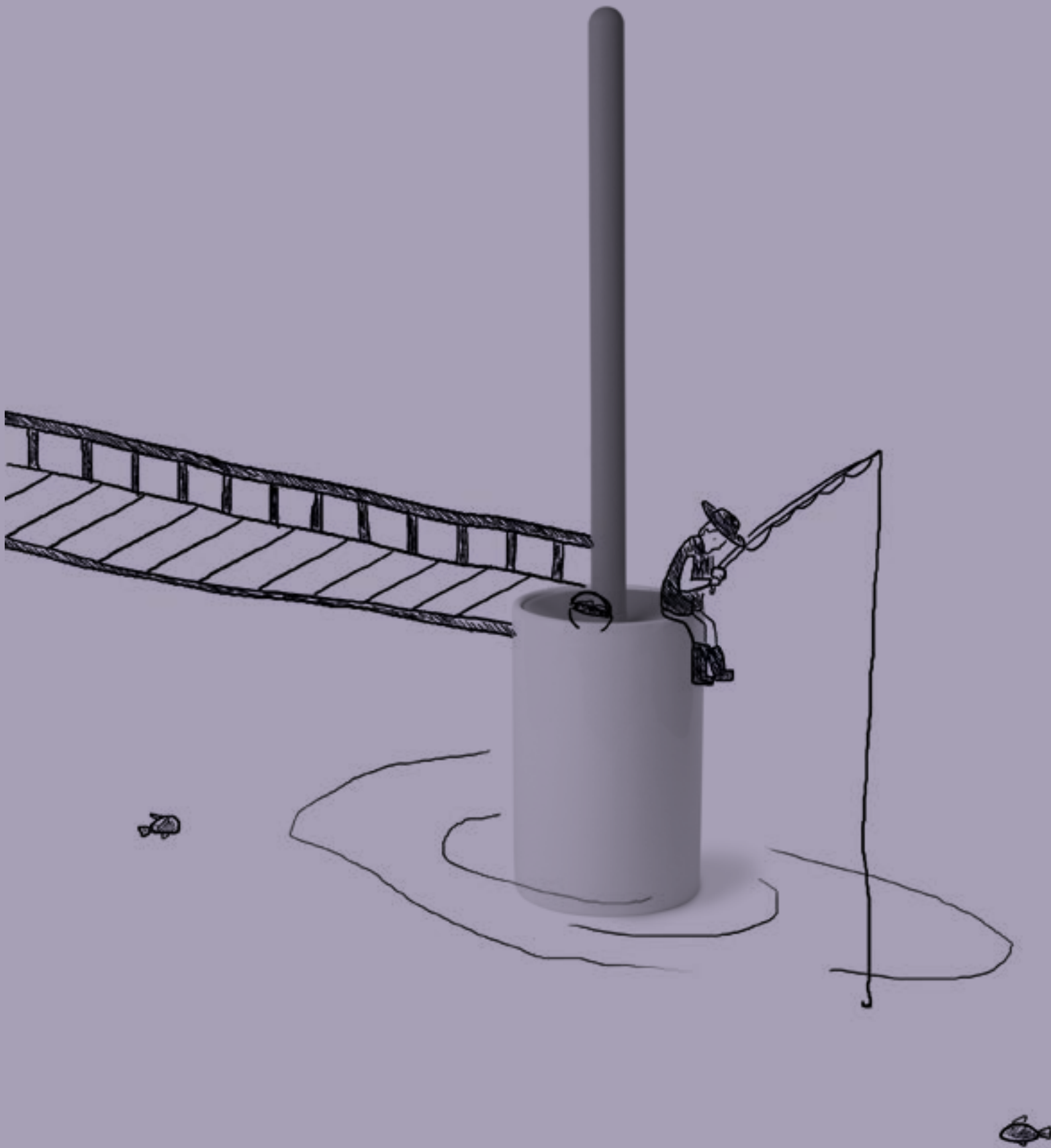



Bastoncino. Impugnature che prendono ispirazione dai bastoni da passeggio per questa ironica collezione di scopini da bagno disegnati nel 2012 da Studio Zaven. Il manico è in alluminio rivestito di colorato e morbido silicone, mentre la base è in ceramica bianca. Il ciuffo è in silicone dello stesso colore del manico.

EN~ *Stick. Designed by Studio Zaven in 2012, the ironic handles of this toilet brush collection resembles old walking sticks. The handle is silicon covered aluminium and a white ceramic base. Sweeper is made in silicon with matching color.*

FR~ *Manche inspiré des bâtons de randonnée pour cette ironique collection de brosses de toilettes, conçues en 2012 par Studio Zaven. La poignée est en aluminium revêtu de silicone doux et coloré, alors que la base est en céramique blanche. Les poils de brosse sont en silicone de même couleur que le manche.*

DE~ *Die Inspiration für diese ironische Sammlung von Badebürsten hatte das Studio Zaven im Jahr 2012 und setzte diese Ideen entsprechend um. Der Griff ist aus Aluminium mit farbigem und weichen Silikon beschichtet, während die Basis aus weißer Keramik besteht. Die Büschel sind aus Silikon in der gleichen Farbe wie der Griff hergestellt.*



5021



5022



5023



5024

5021.17 Portascopino

Toilet brush holder

Porte balai

Toilettenbürstengarnitur

→ 105 ↑ 450 ↗ 145



5023.11 Portascopino

Toilet brush holder

Porte balai

Toilettenbürstengarnitur

→ 105 ↑ 450 ↗ 123



5022.15 Portascopino

Toilet brush holder

Porte balai

Toilettenbürstengarnitur

→ 105 ↑ 450 ↗ 105

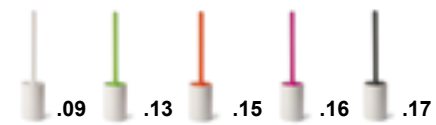

5024 Portascopino

Toilet brush holder

Porte balai

Toilettenbürstengarnitur

∅ 95 ↑ 450



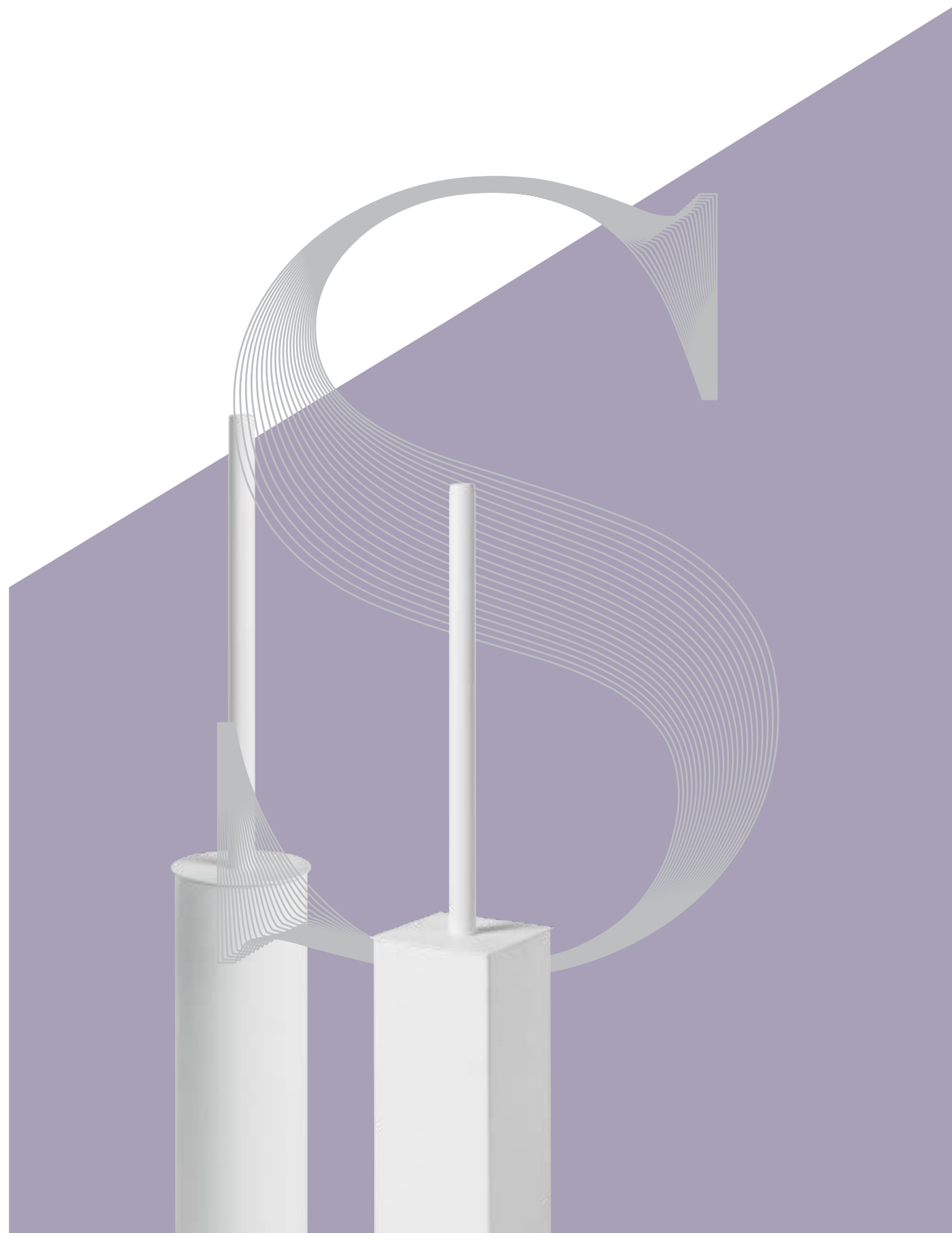

Brutti. Collezione di scopini da bagno con tazza. In ottone cromato, acciaio, ceramica, da muro o da appoggio. Dotati di ciuffo in silicone o con spazzola e tazza in plastica rimovibile.

EN~ *Ugly; Collection of toilet brush holders. Made of chromed brass, stainless steel, ceramic, wall or freestanding. Provided with silicon sweeper or brush scrubber and plastic removable container.*

FR~ *Collection de porte-balai, en laiton chromé, acier, céramique, muraux ou à poser. Dotés de brosse en silicone, ou avec brosse et bol amovible en plastique amovible.*

DE~ *Sammlung von Bürsten für das Bad mit Tasse. Aus verchromtem Messing, Stahl, Keramik, für die Wand oder Arbeitsplatte. Ausgerüstet mit Silikon oder mit Bürsten und herausnehmbarem Kunststoffbecher.*



5004

50041

50051

50053

50054

50203

50207



5008

5012

5011

5013

5010

5015

5014



5004 Portascopino

Toilet brush holder
Porte balai
Toilettenbürstengarnitur

Ø 80 ↑ 540

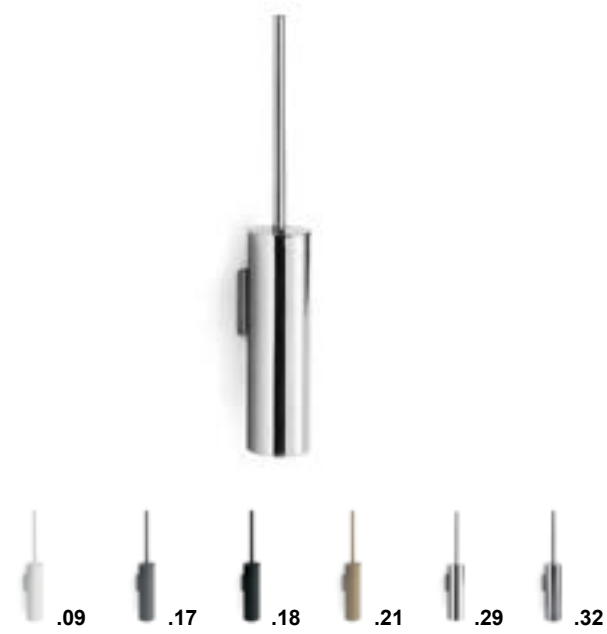

50041 Porta scopino a parete

Wall toilet brush holder
Porte-balai mural
Toilettenbürstengarnitur Wandmodell

→ 90 ↑ 540 ↗ 90



50054.29 Portascopino quadro

Square toilet brush holder
Porte-balai carré
Quadratisch WC-Bürste

→ 80 ↑ 385 ↗ 80



50203.29.09 Portascopino

Toilet brush holder
Porte-balai
Toilettenbürstengarnitur

Ø 93 ↑ 450



50051 Portascopino quadro

Square toilet brush holder
Porte-balai carré
Quadratisch WC-Bürste

→ 85 ↑ 540 ↗ 85



50053 Portascopino quadro a parete

Wall square toilet brush holder
Porte-balai carré mural
Toilettenbürstengarnitur quadratisch Wandmodell

→ 85 ↑ 540 ↗ 90



50207.29 Portascopino

Toilet brush holder
Porte-balai
Toilettenbürstengarnitur

Ø 90 ↑ 410



5008.29 Portascopino

Toilet brush holder
Porte-balai
Toilettenbürstengarnitur

Ø 110 ↑ 390

5012.29 Portascopino "PESSÉ"
Toilet brush holder "PESSÉ"
Porte-balai "PESSÉ"
Toilettenbürstengarnitur "PESSÉ"

→ 150 ↑ 470 ↗ 200

5011.29 Portascopino "BUTTO"
Toilet brush holder "BUTTO"
Porte-balai "BUTTO"
Toilettenbürstengarnitur "BUTTO"

Ø 125 ↑ 475

5015.29 Portascopino "CALA"
Toilet brush holder "CALA"
Porte-balai "CALA"
Toilettenbürstengarnitur "CALA"

Ø 115 ↑ 420

5013.29 Portascopino "VOVO"
Toilet brush holder "VOVO"
Porte-balai "VOVO"
Toilettenbürstengarnitur "VOVO"

Ø 115 ↑ 455

5014.29 Portascopino "LONGA"
Toilet brush holder "LONGA"
Porte-balai "LONGA"
Toilettenbürstengarnitur "LONGA"

Ø 90 ↑ 550

5010.29 Portascopino "BAJLE"
Toilet brush holder "BAJLE"
Porte-balai "BAJLE"
Toilettenbürstengarnitur "BAJLE"

Ø 110 ↑ 460



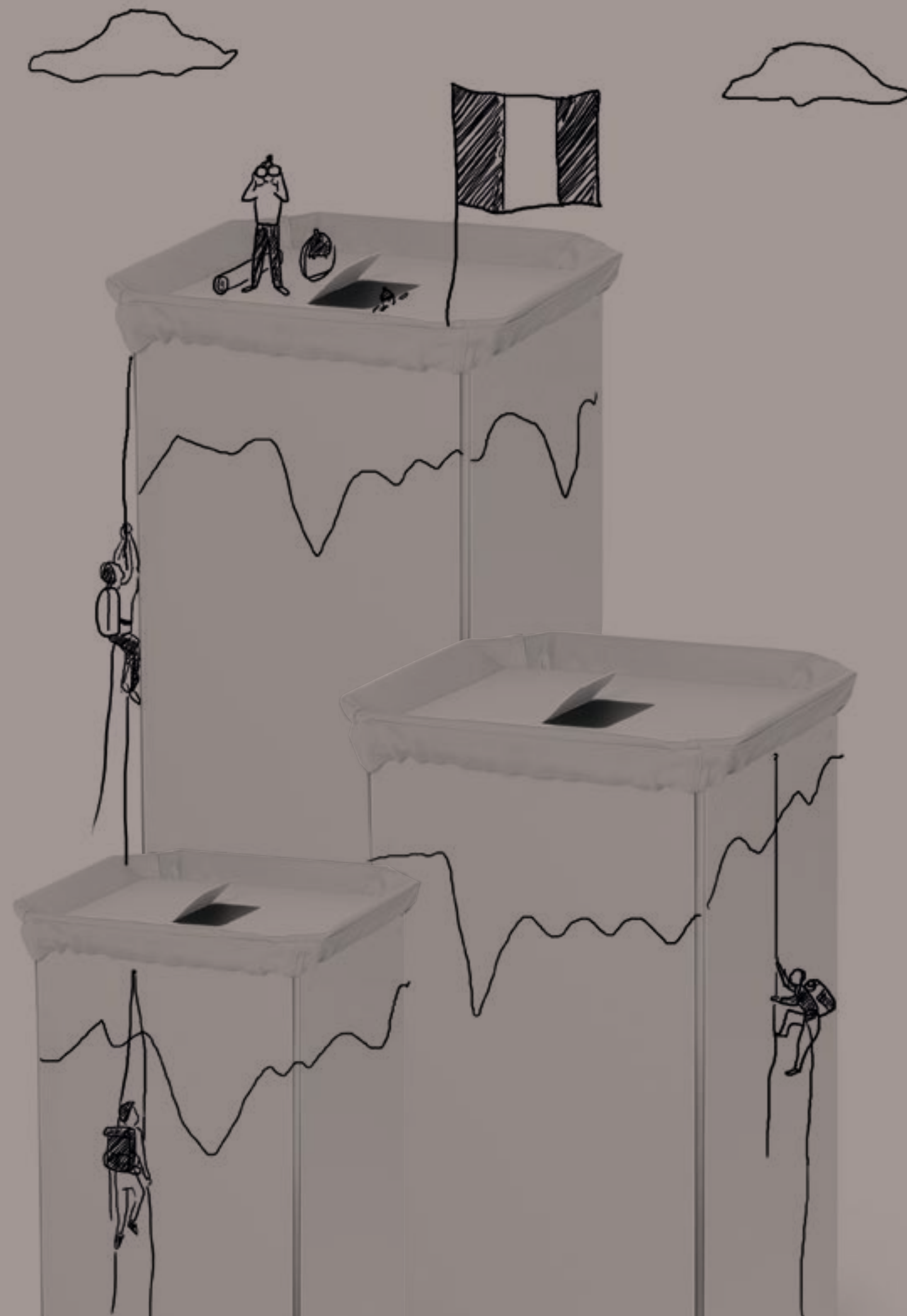

Collezione Complementi
Complements Collection
Collection Compléments
Kollektion Ergänzungen

TAPEI	Tappeti cotone / Cotton rugs / <i>Tapis en coton / Teppich aus Baumwolle</i>	381
BANDONI	Cesti alluminio verniciato / Painted aluminium baskets / <i>Corbeilles et paniers à linge en aluminium verni / Körbe aus lackiertem Aluminium</i>	385
BASKET	Cesti acciaio inox / Stainless steel baskets / <i>Corbeilles et paniers à linge en acier inox / Körbe aus Edelstahl</i>	389
SESTI	Cesti metallo brunito / Burnished metal baskets / <i>Paniers à linge en métal bruni / Körbe aus brüniertem Metall</i>	395
SCAGNI	Sgabelli / Stools / <i>Tabourets / Hocker</i>	399



TAPEI

Tappeti (Ta-peì) per camminare scalzi e comodi su trame di cotone spesse e ricercate, fatti a mano.

EN~ *Rugs for walking barefoot on thick and comfortable and refined cotton plots, hand made.*

FR~ *(Ta-peì) Tapis pour marcher pieds-nus et confortable sur trames de coton épaisses et recherchées, fait à la main.*

DE~ *(Ta-peì) Teppiche über die Sie barfuß gehen können, mit komfortablen und eleganten Baumwoll-Ausführungen, Handgemacht.*



71918



71920



71921



71922

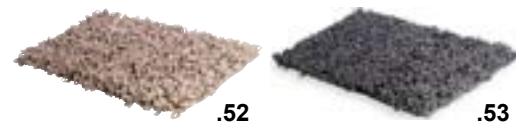

71918 Tappeto decorato "ciuffi"

"Spouts" decorated rug
Tapis décoré "Touffes"
Teppich Dekoration "Büschel"

→ 600 ↗ 1200

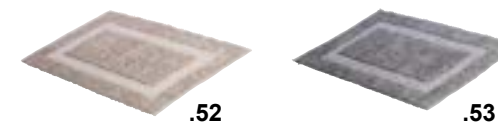

71921 Tappeto decorato "Cornice Bolle"

"Bubble Frame" decorated rug
Tapis décoré "Cadre bulles"
Teppich Dekoration "Blasen am Rahmen"

→ 600 ↗ 1000

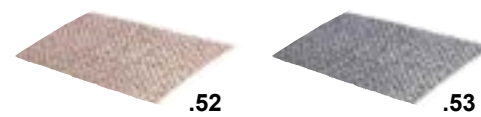

71920 Tappeto decorato "Bolle"

"Bubbles" decorated rug
Tapis décoré "Bulles"
Teppich Dekoration "Blasen"

→ 600 ↗ 1200

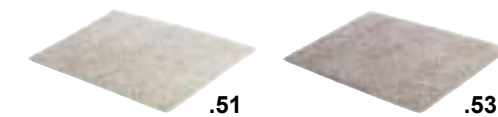

71922 Tappeto Luxury Collection, cotone-lino

Luxury Collection rug cotton-linen
Tapis Luxury Collection coton-lin
Teppich Luxury Collection
Baumwolle-Leinen

→ 600 ↗ 1000





Bidoni. Getta carta, portabiancheria e porta fazzolettini in alluminio verniciato a polvere. I cesti portabiancheria sono dotati di sacchetto in cotone. Collezione disegnata da studio JoeVelluto nel 2012.

EN~ *Can, Paper, laundry and tissue holder made of dust painted aluminium. Laundry basket are provided with a white cotton bag. Collection designed by JoeVelluto studio in 2012.*

FR~ *Corbeille à papier, panier à linge et porte-mouchoirs en aluminium verni à la poudre. Les paniers à linge sont dotés d'un sac en coton. Collection conçue par le studio JoeVelluto en 2012.*

DE~ *Kleines Eimerchen für Papier, Wäsche und Taschentücher aus pulverbeschichtetem Aluminium. Die Wäschekörbe sind mit Baumwolltaschen ausgestattet. Kollektion entworfen vom Studio JoeVelluto im Jahr 2012.*



53441

53442

53443



53441 Portafazzoletti

Tissue holder
Distributeur de mouchoirs
Papierhandtüchspender

→ 280 ↑ 90 ↗ 160



53442 Cestino gettacarta

Paper basket
Poubelle papier
Papierkorb

→ 220 ↑ 325 ↗ 260



53443 Cesto portabiancheria

Laundry basket with bag
Panier à linge avec sac
Wäschekorb mit Sack

→ 300 ↑ 600 ↗ 350



BASKET



Il metallo è il protagonista di questa collezione di portabiancheria, getta carta e pattumiere dalla forma cilindrica, con o senza coperchio, in acciaio inox lucido quale garanzia di durata e facilità di pulizia.

EN~ *Metal is the protagonist of this cylindric laundry and paper containers, with or without cover, made of durable hygienic polished stainless steel.*

FR~ *Le métal est un personnage de cette collection de paniers à linge, corbeilles à papier et poubelles de forme cylindrique, avec ou sans couvercle, en acier inox brillant, lequel garantit durée et facilité de nettoyage.*

DE~ *Metall ist der Protagonist in dieser Sammlung für Wäsche-, Einwegpapier- und Abfallbehälter aus in zylindrischer Form, mit oder ohne Deckel, aus poliertem Edelstahl als Garant für Langlebigkeit und einfache Reinigung.*



5344
5347



5345
5348



53297
53298



5354
5355



5346
5349



5350



5351
5352 - 5353



5356



5357

Pattumiera con secchiello

Dustbin with bucket

Poubelle avec seau

Abfalleimer mit Eimer

5344.29	∅ 185	↑ 275	↗ 220	3 Lt
5347.29	∅ 220	↑ 325	↗ 250	5 Lt



Pattumiera con secchiello

Dustbin with bucket

Poubelle avec seau

Abfalleimer mit Eimer

53297.29	∅ 185	↑ 275	↗ 265	3 Lt
53298.29	∅ 225	↑ 335	↗ 305	5 Lt



Gettacarta

Paper basket

Corbeille à papier

Papierkorb

5345.29	∅ 200	↑ 320	10 Lt
5348.29	∅ 250	↑ 370	18 Lt



Pattumiera con secchiello

Dustbin with bucket

Poubelle avec seau

Abfalleimer mit Eimer

5354.29	∅ 167	↑ 206	3 Lt
5355.29	∅ 205	↑ 280	5 Lt



Gettacarta forato

Perforated paper basket

Corbeille à papier percé

Papierkorb gelocht

5346.29	∅ 200	↑ 320	10 Lt
5349.29	∅ 250	↑ 370	18 Lt

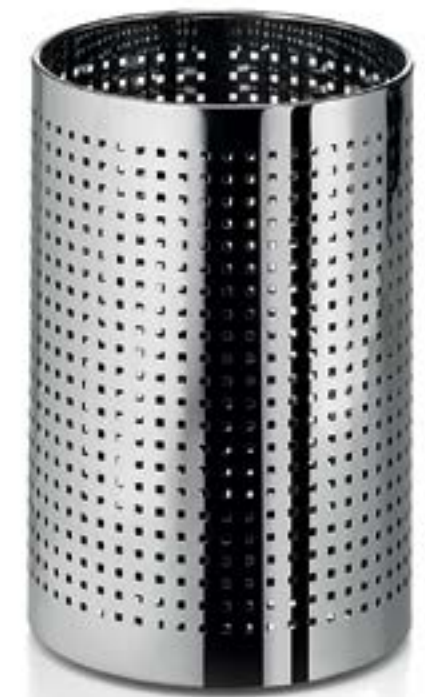



5350.29.29 **Gettacarta con coperchio**
 Perforated paper basket with lid
 Corbeille à papier percé avec couvercle
 Papierkorb gelocht mit Deckel
 Ø 210 ↑ 320 10 Lt



5356.32 **Pattumiera con apertura elettrica sensibile al movimento**
 Dustbin with electric motion sensor opener
 Poubelle ouverture électrique
 Elektronischer Sensor Abfalleimer
 → 243 ↑ 350 ↗ 243 9 Lt



Portabiancheria con coperchio
 Perforated laundry basket with lid
 Panier à linge percé avec couvercle
 Wäschekorb gelocht mit Deckel

5351.29.29	Ø 310	↑ 540	35 Lt
5352.29.29	Ø 365	↑ 560	55 Lt
5353.29.29	Ø 410	↑ 570	70 Lt



5357.32 **Pattumiera rettangolare**
 Rectangular dustbin
 Poubelle Rectangulaire
 Abfalleimer rechteckig
 → 285 ↑ 365 ↗ 256 12 Lt



Sesti. Fantasiata collezione di portabiancheria in metallo brunito traforato, dotati all'interno di un sacco in tela di cotone bianco. Disponibili modelli rettangolari e cilindrici, tutti dotati di coperchio. Entrano in collezione anche i nuovi portabiancheria in morbido tessuto.

EN~ *Willow baskets. Creative collection of burnished metal laundry containers with a white cotton bag. Available rectangular and cylindrical models with cover.*

FR~ *Collection fantaisiste de paniers à linge en métal bruni percé, dotés à l'intérieur d'un sac en toile de coton blanc. Sont disponibles des modèles rectangulaires et cylindriques, tous dotés de couvercles.*

DE~ *Schöne Kollektion für Wäsche aus perforiertem und polierten Metall, in mit einem weißen Baumwoll-Behälter ausgestattet. Erhältlich als rechteckiges und zylindrisches Modell, die alle mit einem Deckel versehen sind.*



53309



53310



53311



53312



7007.47



7007.58

53309.50 Portabiancheria con coperchio e sacco in cotone

Laundry basket with cotton bag and lid

Panier à linge avec couvercle et sac en coton

Wäschekorb mit Deckel und Sack aus Baumwolle

→ 405 ↑ 670 ↗ 405



53310.50 Portabiancheria con coperchio e sacco in cotone

Laundry basket with cotton bag and lid

Panier à linge avec couvercle et sac en coton

Wäschekorb mit Deckel und Sack aus Baumwolle

→ 405 ↑ 670 ↗ 405



53311.50 Portabiancheria con coperchio e sacco in cotone

Laundry basket with cotton bag and lid

Panier à linge avec couvercle et sac en coton

Wäschekorb mit Deckel und Sack aus Baumwolle

∅ 430 ↑ 650



53312.50 Portabiancheria con coperchio e sacco in cotone

Laundry basket with cotton bag and lid

Panier à linge avec couvercle et sac en coton

Wäschekorb mit Deckel und Sack aus Baumwolle

∅ 430 ↑ 650



7007 Portabiancheria ripiegabile morbido con manici e rete richiudibile

Foldable laundry basket with handles and tightening net

Panier à linge repliable avec poignées

Wäschesack mit Griff verschließbar mit Netz

∅ 340 ↑ 510



Sgabelli. Collezione di sgabelli dalle forme e materiali eterogenei. Ottone cromato, mattstone bianco, metallo brunito per le versioni da appoggio, teak e acciaio inox insieme per quella ribaltabile.

EN~ *Stools. Collection of heterogeneous stools made of different materials. Chromed brass, white mattstone and burnished metal for freestanding version, teak and stainless steel for the flippable one.*

FR~ *Collection de tabourets de formes et matériaux hétérogènes. Laiton chromé, pierre composite blanche, métal bruni pour les versions de support, teck et acier inox pour celle rabattable.*

DE~ *Kollektion aus Hockern in verschiedenen Formen und Materialien. Messing verchromt, mattstone weiß, brüniert Metall für Versionen von Unterstützung, Teak und Edelstahl zusammen mit dem Kipper.*



54703



54702



54709



54710



54720

54703.26 Sgabello in mattstone

Mattstone stool

Tabouret en mattstone

Hocker aus Mattstone

→ 400 ↑ 430 ↗ 300



54710.50 Sgabello in metallo brunito

Brunished metal stool

Tabouret métal bruni

Hocker aus brüniertem Metall

∅ 330 ↑ 430



54702.26 Sgabello in mattstone

Mattstone stool

Tabouret en mattstone

Hocker aus Mattstone

→ 345 ↑ 375 ↗ 325



54709.50 Sgabello in metallo brunito

Brunished metal stool

Tabouret métal bruni

Hocker aus brüniertem Metall

→ 330 ↑ 430 ↗ 330



54720.29 Sedile doccia in teak

Teak shower seat

Siège de douche en teak

Duschsitz aus Teak

→ 400 ↑ 110 ↗ 340



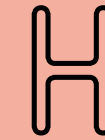

Hotel & Contract
Hotel & Contract
Hôtel
Hotel



OTEL

Accessori hotellerie / Hotel Accessories /
Accessoires hôtellerie / Hotel Zubehör

405





Albergo. Collezione di accessori e complementi per il bagno del contract alberghiero o per la collettività realizzati in vari materiali, che rispondono a severe certificazioni sulla sicurezza, qualità dei materiali e affidabilità.

EN~ *Hotel. Accessories and complements collection for hospitality or public spaces made in various materials, answering to severe safety certifications, quality and reliability.*

FR~ *Collection d'accessoires et compléments pour la salle de bain du contract hôtelier ou pour la collectivité, fabriqués en divers matériaux, qui répondent à des certifications strictes sur la sécurité, la qualité des matériaux et la fiabilité.*

DE~ *Sammlung von Zubehör und Ergänzungen für das Bad für Hotels, aus verschiedenen Materialien hergestellt, die in punkto Sicherheit und der Qualität der Materialien und Zuverlässigkeit höchste Sicherheitsstandards erfüllen.*

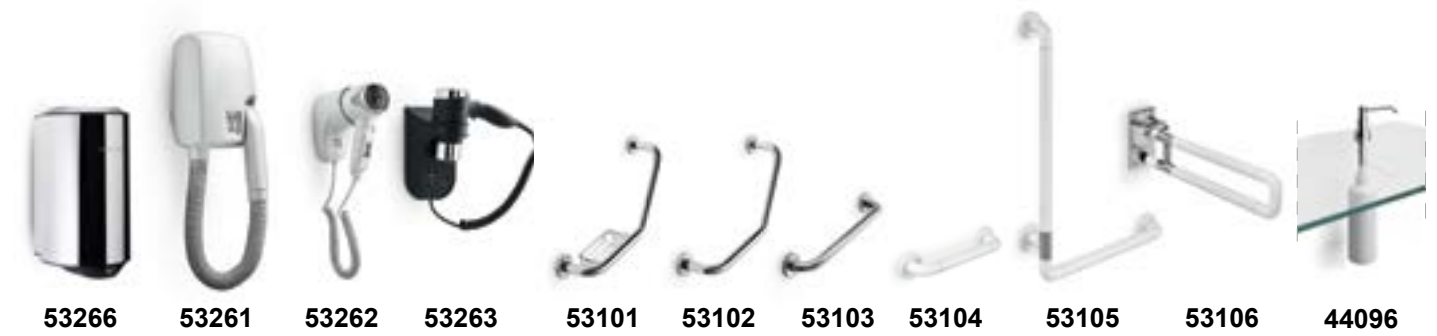

53266 53261 53262 53263 53101 53102 53103 53104 53105 53106 44096



53267 53269 53270 53271 53272 53291 53292 53293 53294



44019 44020 53295

53261 Asciugacapelli a parete con presa per rasoio 110-220 V*Wall hairdryer with shaver socket 110-220 V**Sèche-cheveux électrique mural avec prise pour rasoir 110V-220V**Wand-Haartrockner mit Rasiersteckdose 110V-220V*

→ 175 ↑ 260 ↗ 125

**53262** Asciugacapelli a parete, 2 velocità*Wall hairdryer, 2 speeds**Sèche-cheveux électrique mural, 2 vitesses**Wand-Haartrockner, 2 Schaltstufen*

→ 90 ↑ 200 ↗ 160

**53263** Asciugacapelli a parete con presa per rasoio 110-220 V*Wall hairdryer with shaver socket 110-220 V**Sèche-cheveux électrique mural avec prise pour rasoir 110V-220V**Wand-Haartrockner mit Rasiersteckdose 110V-220V*

→ 110 ↑ 255 ↗ 295

**53266.29** Asciugamani elettrico a parete in acciaio inox con attivazione sensore di movimento 220-240 V - 500 Watt*Wall handdryer with motion sensor activation in stainless steel 220-240 V - 500 Watt**Sèche-mains électrique avec capteur de mouvement en acier inox 220-240 V - 500 Watt**Elektronischer Wandtrocker mit Sensor aus Edelstahl 220-240 V - 500 Watt*

→ 145 ↑ 280 ↗ 163



53101.29 Maniglione di sicurezza reversibile, con porta sapone

Reversible grab security bar with soap holder

Poignée de sûreté reversible avec porte-savon

Sicherheitsgriff mit Seifenkorb wechselseitig

→ 455 ↑ 250 ↗ 110



53102.29 Maniglione di sicurezza reversibile

Reversible grab security bar

Poignée de sûreté reversible

Sicherheitsgriff wechselseitig

→ 445 ↑ 250 ↗ 110



53103.29 Maniglione di sicurezza

Grab security bar

Poignée de sûreté

Sicherheitsgriff

→ 430 Ø 57 ↗ 80



53104 Maniglione di sicurezza



Grab security bar

Poignée de sûreté

Sicherheitsgriff

→ 420 Ø 80 ↗ 90



53105 Maniglione di sicurezza reversibile



Reversible grab security bar

Poignée de sûreté reversible

Sicherheitsgriff wechselseitig

→ 800 Ø 80 ↗ 620



53106 Maniglione di sicurezza ribaltabile



Folding safety support

Poignée de sûreté rabattable

Klapp-Sicherheitsgriff

→ 115 ↑ 200 ↗ 615



44096.29 Dosasapone sottopiano 1 lt

Undertop soap dispenser 1 lt
Distributeur savon liquide sous-plan 1 lt
Unterplatte Seifenspender 1 lt

→ 84 ↑ 640 ↗ 164

**53267.29** Dosatore a parete singolo 400 ml

Wall bearing liquid soap dispenser 400 ml
Distributeur savon liquide mural 400 ml
Wandseifenspender 400 ml

→ 75 ↑ 240 ↗ 70

**53269.29** Raccogli goccia

Drop-catcher
Protège-gouttes
Abtropfplatte

→ 70 ↑ 16,5 ↗ 90

ITALY AISI 304

**53270.29** Portafazzoletti igienici da tavolo

Table kleenexbox
Porte-mouchoirs d'appui
Kleenexbox am Tisch

→ 125 ↑ 128 ↗ 130

ITALY AISI 304

**53271.29** Porta fazzoletti da tavolo

Wall / Table kleenexbox
Porte-mouchoirs d'appui ou au mur
Kleenexbox am Tisch / Wand

→ 250 ↑ 70 ↗ 125

ITALY AISI 304

**53272.29** Porta sacchetti igienici a muro

Wall sanitary bag holder
Distributeur sachets hygiéniques au mur
Hygienebeutelspender am Wand

→ 95 ↑ 135 ↗ 32

ITALY AISI 304



53291.29 Porta fazzoletti da parete e da appoggio*Wall/table kleenexbox**Porte-mouchoirs d'appui ou mural**Kleenexbox am Tisch/Wand*

→ 265 ↑ 140 ↗ 55

AISI
304**53292.29** Distributore jumbo carta igienica*Jumbo roll toilet tissue dispenser**Porte-papier grand**Spender für Toilettenpapier Jumbo*

→ 260 ↑ 265 ↗ 130

AISI
304**53293.29** Porta sacchetti igienici*Sanitary bag holder**Distributeur sachets hygiéniques**Hygienebeutelspender*

→ 130 ↑ 280 ↗ 60

AISI
304**53294.29** Distributore asciugamani di carta*Paper towels dispenser**Distributeur porte-serviettes en papier**Papiertücherspender*

→ 280 ↑ 365 ↗ 100

AISI
304**44019.29** Bidoncino da tavolo tondo inox*Round table paper bin**Petite boîte ronde à ordures pour la table**Tischabfallbehälter rund*

Ø 120 ↑ 163

NEW

**44020.29** Bidoncino da tavolo quadrato inox*Square table paper bin**Petite boîte carrée à ordures pour la table**Tischabfallbehälter quadratisch*

→ 118 ↑ 157 ↗ 118

NEW

**53295.29** Filo stendibiancheria 250 mm*Retractable clothesline 250 mm**Fil étendoir 250 mm**Wäscheleine 250 mm*

→ 33 ↑ 66 ↗ 50 Ø 92

AISI
304

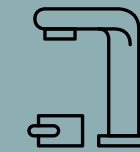

Collezione Sifoni, Pilette
& Rubinetteria

Siphons, Water Drains and Faucets

Siphons, Bondes et Robinetterie

Siphons, Ablaufgarnituren und Armaturen



BUSI & CANE	Sifoni e pilette / <i>Siphons and water drains / Siphons et bondes / Siphons und Ablaufgarnituren</i>	417
LINEA	Prese acqua / <i>Water outlet / Sorties d'eau / Wandanschlussbogen</i>	423
CANOLE	Rubinetteria acciaio inox / <i>Stainless steel faucets / Robinetterie en acier inox / Armatur aus Edelstahl</i>	427
LNOX	Rubinetteria acciaio inox / <i>Stainless steel faucets / Robinetterie en acier inox / Armatur aus Edelstahl</i>	435
SECIARI	Rubinetteria cucina / <i>Kitchen faucets / Robinetterie pour cuisine / Küchenarmaturen</i>	441

Buchi e canne. Raccordi, sifoni, pilette e ghiere in ottone cromato compatibili con i nostri prodotti. Ideali per ogni tipo di ambiente: moderno, elegante, raffinato e minimal. Attenzione e cura per prodotti, che normalmente si tendono a nascondere.

EN~ *Holes and rods. Chromed brass joints, syphons, drains and grids compatible with our products. Idea for every kind of space: modern, elegant, sophisticated and minimal. Attention and concern for details and products that normally are hidden.*

FR~ *Raccords, siphons, drains et base d'appui en laiton chromé compatibles avec nos produits. Idéaux pour tout type d'environnement : moderne, élégante, raffiné et minimal. Attention et soin pour les produits, qui sont généralement cachés de la vue.*

DE~ *Armaturen, Siphons, Abflüsse und verchromten Messingringe kompatibel mit unseren Produkten. Ideal für jede Umgebung: modern, elegant, raffiniert und minimal. Platz zum Versteuen von Produkten, die gerne zum Verschwinden neigen.*



5392

53921

53922

53925

53926

53927



53960

53961

53971 - 53972 - 53975

53991 - 53992

53993 - 53994 - 53995

5398

5392.29 Sifone 1"-1/4 mm

Siphon, 1"-1/4 mm

Siphon 1"1/4 mm

Siphon 1" 1/4 mm

Ø 44 ↑ 90 - 190 max ↗ 290 max



53921.29 Sifone salvaspazio, 1"-1/4 mm

Space saving siphon, 1"-1/4 mm

Siphon gain de place 1"1/4 mm

Siphon platzsparend 1" 1/4 mm

Ø 50 ↑ 172 - 220 max ↗ 170 - 360 max



53922.29 Sifone 1"-1/4 mm

Siphon, 1"- 1/4 mm

Siphon 1"1/4 mm

Siphon 1" 1/4 mm

Ø 50 ↑ 65 - 160 max ↗ 290 max



53925.29 Sifone quadro 1"-1/4 mm

Square siphon, 1"- 1/4 mm

Siphon carré 1"1/4 mm

Siphon quadratisch 1" 1/4 mm

Ø 45 ↑ 65 - 160 max ↗ 290 max



53926.29 Sifone per bidet, 1"-1/4 mm

Bidet siphon 1" - 1/4 mm

Siphon bidet 1" 1/4 mm

Bidet Siphon 1" 1/4 mm

Ø 50 ↑ 60 - 120 max ↗ 290 max



53927.29 Sifone salvaspazio, 1"-1/4 mm

Space saving siphon 1" - 1/4 mm

Siphon gain de place 1" 1/4 mm

Siphon 1" 1/4 mm platzsparend



Ø 32 ↑ 380 max ↗ 350 max



5398.29 Ghiera appoggio vasche soprapiano

Support nut for washbasins

Base d'appui pour vasques à poser

Aufsatzring für Waschbecken

Ø 63 ↑ 12



53960.29 Piletta pavimento clik 100x100 mm

*Automatic floor waste water drain
100x100 mm*

*Bonde automatique au sol
100x100 mm*

*Druck-Abflussgarnitur für Boden
100x100 mm*

→ 100 ↑ 42 ↗ 100



53961.29 Piletta click regolabile 0-60 mm, 1" 1/4"

*Automatic floor waste water drain
adaptable 0-60 mm 1" 1/4"*

*Bonde automatique réglable 0-60 mm
1" 1/4"*

Druck-Abflussgarnitur verstellbar 1" 1/4"

Ø 42 ↑ 70 max



Piletta scarico libero, 1"- 1/4 mm

Free waste water drain, 1" - 1/4 mm

Bonde à écoulement libre

Freie Abflussgarnitur 1" 1/4

53971.29 Ø 42 ↑ 30 max

53972.29 Ø 42 ↑ 50 max

53975.29 Ø 42 ↑ 75 max



Piletta automatica click con troppopieno

*Automatic waste water drain with
overflow*

Bonde automatique avec trop-plein

Druck-Abflussgarnitur mit Überlauf

53991.29 Ø 42 ↑ 50 max

53992.29 Ø 42 ↑ 70 max



Piletta automatica click senza troppopieno

*Automatic waste water drain without
overflow*

Bonde automatique sans trop-plein

Druck-Abflussgarnitur ohne Überlauf

53993.29 Ø 42 ↑ 30 max

53994.29 Ø 42 ↑ 50 max

53995.29 Ø 42 ↑ 75 max



LINEA

Linea base di componentistica per la rubinetteria.

EN~ *Baseline components for taps*

FR~ *Ligne de base de composants pour la robinetterie.*

DE~ *Basis-Linie für Zubehör und Armaturen*

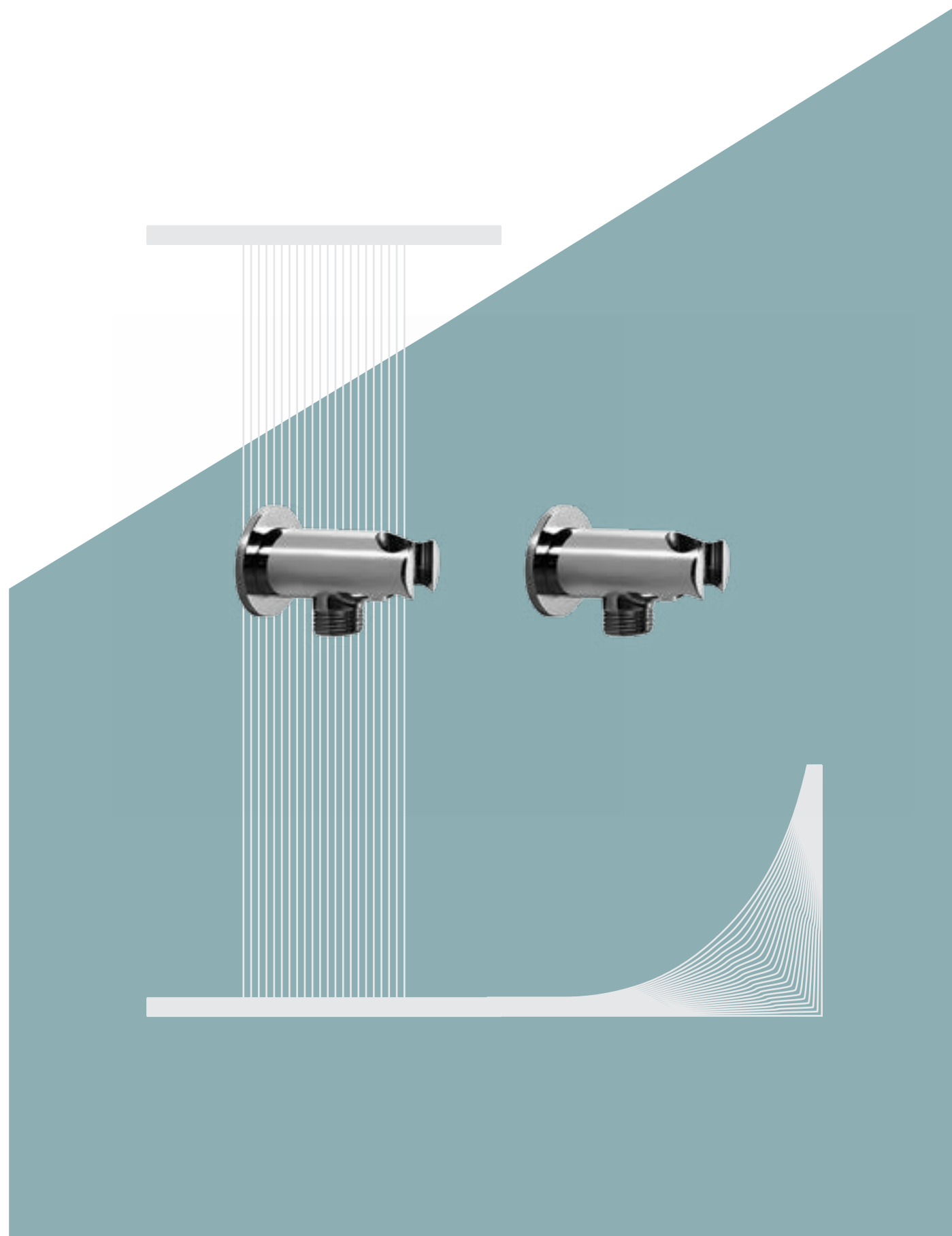

54198



54199



54208



54203



54204



54209

54198.29 Presa acqua tonda con supporto doccia*Round water outlet with shower hook**Sortie d'eau ronde avec crochet pour douche**Wandanschlussbogen rund mit Brausehalterung*

→ 88 ↑ 50 ↗ 45

**54203.29 Presa acqua tonda, uscita 1/2"***Round water outlet 1/2"**Sortie d'eau ronde, 1/2"**Wandanschlussbogen 1/2"*

→ 70 ↑ 48 ↗ 42

**54199.29 Presa acqua quadra con supporto doccia***Square water outlet with shower hook**Sortie d'eau carrée avec crochet pour douche**Wandanschlussbogen quadratisch mit Brausehalterung*

→ 88 ↑ 50 ↗ 45

**54204.29 Presa acqua quadra, uscita 1/2"***Square water outlet 1/2"**Sortie d'eau carrée, 1/2"**Wandanschlussbogen quadratisch 1/2"*

→ 80 ↑ 45 ↗ 42

**54208.29 Rubinetto arresto tondo 1/2" uscita 3/8***Concealed stop valve round 1/2" with connection 3/8**Robinet d'arrêt rond 1/2" sortie 3/8"**Unterputzstopventil rund 1/2" Anschluß 3/8*

→ 80 ↑ 65 ↗ 50

**54209.29 Rubinetto arresto quadro uscita 3/8***Concealed stop valve square 1/2" with connection 3/8**Robinet d'arrêt carré 1/2" sortie 3/8"**Unterputzstopventil quadratisch 1/2" Anschluß 3/8*

→ 75 ↑ 53 ↗ 50



CANOLE

La bellezza richiede anche la tecnica. Il prodotto deve essere disegnato tenendo presente la qualità e la funzionalità, ma deve anche essere diverso. Disegnare rubinetteria con forme leggere e ridotte sembra facile. E così è.

EN~ *Beauty also requires technique. The product has to be designed for functionality and quality, but it must also be different. To design and produce taps with light and reduced shapes seems easy. And indeed it is.*

FR~ *La beauté exige aussi la technique. Le produit doit être conçu en gardant à l'esprit la qualité et la fonctionnalité, mais doit aussi être différent. Concevoir la robinetterie avec des formes légères et réduites semble facile. Et ça l'est.*

DE~ *Schönheit erfordert auch Technik. Das Produkt ist ausgelegt, Qualität und Funktionalität zu erfüllen, dabei aber auch unterschiedlich sein muß. Design für Armaturen, mit leichten und reduzierten Formen scheint einfach. Und so ist es.*

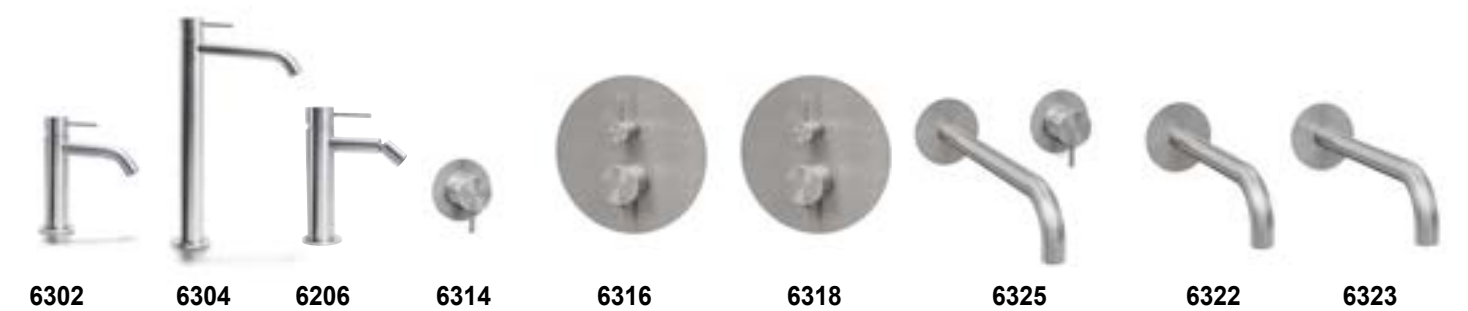

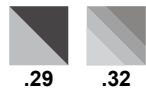

6302 Miscelatore monocomando lavabo

Single lever washbasin mixer
 Mitigeur monotrou pour lavabo
 Einhebel Mischer für Waschtisch

∅ 35 ↑ 166 ↗ 148

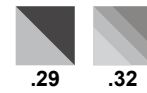

6304 Miscelatore monocomando lavabo alto

High single lever washbasin mixer
 Mitigeur monotrou haut pour lavabo
 Höher Einhebel Mischer für Waschtisch

∅ 35 ↑ 335 ↗ 191

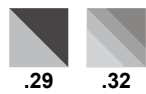

6206 Miscelatore monocomando bidet

Single lever bidet mixer
 Mitigeur monotrou pour bidet
 Einhebel Bidetmischer

∅ 35 ↑ 166 ↗ 125

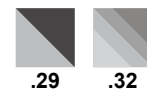

6314 Miscelatore monocomando muro

Wall mounted washbasin mixer
 Mitigeur pour lavabo à encastrer
 Einhebel Mischer Unterputz

→ 70 ↑ 70 ↗ 32

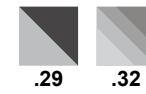

6316 Miscelatore incasso dev. 2 vie

Built-in mixer with 2 exits
 Mitigeur à encastrer avec déviateur 2 sorties
 Einhebel Mischer Unterputz mit
 Zweiswege Umsteller

∅ 160 ↗ 33

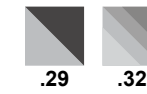

6318 Miscelatore incasso dev. 3 vie

Built-in mixer with 3 exits
 Mitigeur à encastrer avec déviateur 3 sorties
 Einhebel Mischer Unterputz mit
 Dreiswege Umsteller

∅ 160 ↗ 33

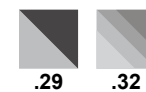

6325 Miscelatore a muro 2 fori con canna

Built-in mixer with spout and 2 holes
 Mitigeur à encastrer avec bec, 2 trous
 Einhebel Mischer Unterputz mit Wan-
 neneinlauf 2 Löcher

→ 70 ↑ 90 ↗ 257

→ 70 ↑ 64 ↗ 38

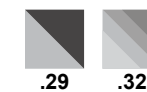

6322 Bocca lavabo a muro 190 mm

Wall mounted spout 190 mm
 Bec 190 mm
 Wanneneinlauf 190 mm

→ 70 ↑ 90 ↗ 197



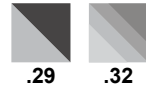

6323 Bocca lavabo a muro 250 mm

Wall mounted spout 250 mm

Bec 250 mm

Wanneneinlauf 250 mm

→ 70 ↑ 90 ↗ 255

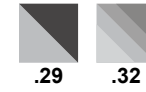

6330 Miscelatore lavabo 3 fori con canna girevole

Washbasin mixer 3 holes with swivel spout

Mitigeur pour lavabo 3 trous avec bec orientable

Mischer für Waschtisch 3 Löcher mit schwenkbarer Auslauf

→ 150 - 200 ↑ 274 ↗ 240

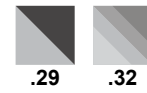

6328 Bocca lavabo top a ponte girevole

Bridge-shaped swivel spout

Bec haut lavabo orientable

Schwenkbarer Brücke-Auslauf

∅ 20 ↑ 274 ↗ 240

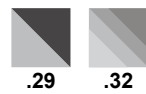

6329 Bocca lavabo top girevole 160°

Shaped swivel spout 160°

Bec haut lavabo orientable 160°

Schwenkbarer Auslauf 160°

∅ 20 ↑ 224 ↗ 178

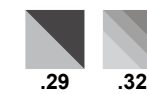

6331 Miscelatore comando top

Single lever countertop mixer

Mitigeur monotrou lavabo

Einhebel Mischer für Platte

→ 55 ↑ 42 ↗ 55



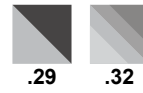

6360 Piantana vasca con doccetta

Floor standing bathtub mixer with handshower

Mitigeur baignoire montage au sol avec douchette

Fußboden Badewanne Mischer mit Handbrause

∅ 60 ↑ 1219 ↗ 459

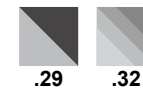

6252 Braccio doccia a soffitto 200 mm

Ceiling mounted head shower spout 200 mm

Bras de douche de plafond 200 mm

Brausearm Deckenmontage 200 mm

∅ 20 ↑ 208

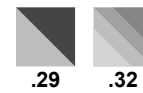

6226 Doccetta con presa acqua e supporto

Water outlet with handshower and holder

Douchette avec sortie d'eau et support

Wandanschlussbogen mit Handbrause und Wandhalterung

→ 70 ↑ 185 ↗ 60

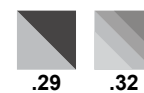

6335 Piantana lavabo

Floor standing washbasin mixer

Mitigeur pour lavabo montage au sol

Fußboden Waschtisch Mischer mit Handbrause

∅ 40 ↑ 1136 ↗ 233

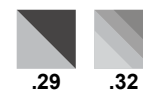

6251 Braccio doccia a parete 300 mm

Wall mounted shower spout 300 mm

Bras de douche 300 mm

Brausearm Wandmontage 300 mm

→ 60 ↑ 100 ↗ 362



Collezione di rubinetti in acciaio inox lucido e satinato dalle linee precise e matematiche per una qualità che dura nel tempo.

EN~ *Collection of faucets in polished and satin stainless steel with precise and mathematical lines designed for quality that lasts.*

FR~ *Collection de robinets en acier inox brillant et brossé aux lignes précises et mathématiques pour une qualité qui dure dans le temps.*

DE~ *Sammlung von Armaturen aus poliertem und satiniertem Edelstahl mit präzisen und mathematischen Linien für Qualität, die bleibt.*



6202

6204

6206

6212

6214



6216

6218

6222

6226

6251

6252

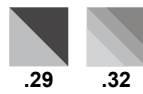

6202 Miscelatore monocomando lavabo

Washbasin single hole mixer without pop-up

Mitigeur monotrou pour lavabo

Einhebel Mischer für Waschtisch

Ø 35 ↑ 166 ↗ 145

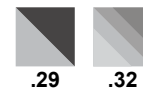

6204 Miscelatore monocomando lavabo alto

High single hole mixer without pop-up for washbasin

Mitigeur monotrou haut pour lavabo

Höher Einhebel Mischer für Waschtisch

→ 35 ↑ 206 ↗ 197

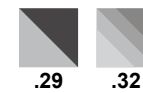

6214 Miscelatore monocomando muro

Wall mounted washbasin mixer

Mitigeur pour lavabo à encastrer

Einhebel Mischer Unterputz

→ 70 ↑ 70 ↗ 34

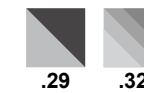

6216 Miscelatore incasso dev. 2 vie

Built-in mixer with 2 exits

Mitigeur à encastrer avec déviateur 2 sorties

Einhebel Mischer Unterputz mit Zweizeige Umsteller

→ 100 ↑ 150 ↗ 36

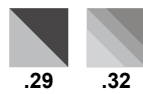

6206 Miscelatore monocomando bidet

Single lever bidet mixer

Mitigeur monotrou pour bidet

Einhebel Bidetmischer

Ø 35 ↑ 166 ↗ 125

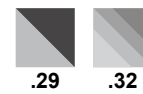

6212 Miscelatore lavabo muro due fori

Built-in mixer 2 holes

Mitigeur à encastrer 2 trous

Einhebel Mischer Unterputz 2 Löcher

→ 70 ↑ 70 ↗ 258

→ 70 ↑ 70 ↗ 34

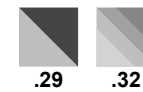

6218 Miscelatore incasso dev. 3 vie

Built-in mixer with 3 exits

Mitigeur à encastrer avec déviateur 3 sorties

Einhebel Mischer Unterputz mit Dreizeige Umsteller

→ 100 ↑ 150 ↗ 34

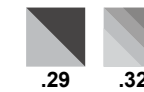

6222 Bocca lavabo a muro 190 mm

Wall mounted spout 190 mm

Bec 190 mm

Wanneneinlauf 190 mm

→ 70 ↑ 70 ↗ 199



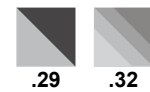

6226 Doccetta con presa acqua e supporto

Water outlet with handshower and holder

Douchette avec sortie d'eau et support

Wandanschlussbogen mit Handbrause und Wandhalterung

→ 70 ↑ 185 ↗ 60

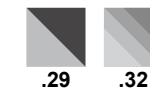

6251 Braccio doccia a parete 300 mm

Wall mounted shower spout 300 mm

Bras de douche 300 mm

Brausearm Wandmontage 300 mm

→ 60 ↑ 100 ↗ 362

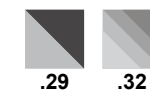

6252 Braccio doccia a soffitto 200 mm

Celing mounted head shower spout 200 mm

Bras de douche de plafond 200 mm

Brausearm Deckenmontage 200 mm

∅ 20 ↑ 208



SECIARI

Secchio (Se-cià-ri) Collezione di rubinetti in cromo e nickel spazzolato per la cucina, con un design elegante e minimale garantiscono funzionalità e qualità.

EN~ *Collection of kitchen faucets in chrome and brushed nickel: an elegant and minimalist design to ensure functionality and quality:*

FR~ *(Se-cià-ri) Seau. Collection de robinets en chrome et nickel brossé pour la cuisine, au design élégant et minimal, qui garantissent fonctionnalité et qualité.*

DE~ *(Se-cià-ri) Eimer. Kollektion von Armaturen in Chrom und gebürstetem Nickel für die Küche, ein elegantes und minimalistisches Design, um Funktionalität und Qualität zu gewährleisten.*



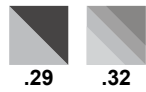

6971 Miscelatore monocomando lavello con bocca girevole

Single lever sink mixer with swivel spout
Mitigeur d'évier mono-commande avec bec orientable
Einhand-Spültischbatterie mit schwenkbarer Auslauf

→ 34 ↑ 297 ↗ 244

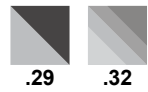

6951 Miscelatore monocomando lavello con bocca girevole e doccetta estraibili

Single lever sink mixer with swivel spout and pull-out shower
Mitigeur d'évier mono-commande avec bec orientable et douchette extractible
Einhand-Spültischbatterie mit schwenkbarer Auslauf und herausziehbare Spülbrause

→ 32 ↑ 444 ↗ 264

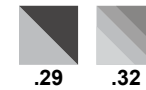

6902 Set miscelatore monocomando lavello con bocca girevole abbattibile e comando remoto top

2-hole sink mixer with retractable swivel spout and remote control on deck
Mitigeur évier 2 trous avec bec orientable et escamotable, manette de commande à distance
Versenkbare Einhand-Spültischbatterie mit schwenkbarer Auslauf und separate Bedienung

→ 150 - 200 ↑ 181 ↗ 261

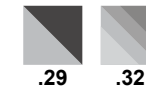

6911 Miscelatore monocomando lavello con bocca girevole

Single lever sink mixer with swivel spout
Mitigeur d'évier mono-commande avec bec orientable
Einhand-Spültischbatterie mit schwenkbarer Auslauf

→ 101 ↑ 303 ↗ 246

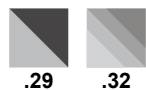

6901 Miscelatore abbattibile monoforo monocomando lavello con bocca girevole

Single lever retractable sink mixer with swivel spout
Mitigeur d'évier mono-commande avec bec orientable et escamotable
Versenkbare Einhand-Spültischbatterie mit schwenkbarer Auslauf

∅ 35 ↑ 58 - 252 ↗ 243

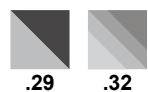

6961 Miscelatore monocomando lavello con bocca girevole

Single lever sink mixer with swivel spout
Mitigeur d'évier mono-commande avec bec orientable
Einhand-Spültischbatterie mit schwenkbarer Auslauf

∅ 32 ↑ 404 ↗ 180

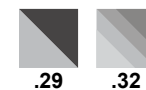

6912 Miscelatore monocomando lavello con bocca girevole e doccetta estraibile

Single lever sink mixer with swivel spout and pull-out shower
Mitigeur d'évier mono-commande avec bec orientable et douchette extractible
Einhand-Spültischbatterie mit schwenkbarer Auslauf und herausziehbare Spülbrause

→ 101 ↑ 306 ↗ 243



6932 Miscelatore monocomando lavello con bocca girevole

Single lever sink mixer with swivel spout
Mitigeur d'évier mono-commande avec bec orientable
Einhand-Spültischbatterie mit schwenkbarer Auslauf

→ 99 ↑ 421 ↗ 249



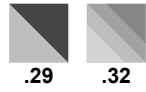

6933 Miscelatore monocomando lavello con bocca girevole e doccetta estraibile a scomparsa

Single lever sink mixer with swivel spout and hidden pull-out shower

Mitigeur d'évier mono-commande avec bec orientable et douchette extractible

Einhand-Spültischbatterie mit schwenkbarer Auslauf und herausziehbare versteckte Spülbrause

→ 99 ↑ 421 ↗ 249



6922 Miscelatore monocomando lavello con bocca girevole

Single lever sink mixer with swivel spout

Mitigeur d'évier mono-commande avec bec orientable

Einhand-Spültischbatterie mit schwenkbarer Auslauf

→ 98 ↑ 346 ↗ 243



6931 Miscelatore monocomando lavello con bocca girevole

Single lever sink mixer with swivel spout

Mitigeur d'évier mono-commande avec bec orientable

Einhand-Spültischbatterie mit schwenkbarer Auslauf

→ 98 ↑ 388 ↗ 238



6921 Miscelatore monocomando lavello con bocca girevole

Single lever sink mixer with swivel spout

Mitigeur d'évier mono-commande avec bec orientable

Einhand-Spültischbatterie mit schwenkbarer Auslauf

→ 117 ↑ 258 ↗ 231



6941 Miscelatore monocomando lavello con bocca girevole e doccetta estraibile

Single lever sink mixer with swivel spout and pull-out shower

Mitigeur d'évier mono-commande avec bec orientable et douchette extractible

Einhand-Spültischbatterie mit schwenkbarer Auslauf und herausziehbare Spülbrause

→ 116 ↑ 276 ↗ 210













Finiture

Finishing / Finition / Finishes



Legno / Wood / Bois / Holz

- | | | | | | |
|---|---|--|---|---|---|
| .03 Bambù Naturale
<i>Natural Bamboo</i>
<i>Bambou Naturel</i>
<i>Natural Bamboo</i> |  | .03 Noce
<i>Wot</i>
<i>Noyer</i>
<i>Walnuss</i> |  | .03 Nero opaco
<i>Matt Black</i>
<i>Noir Mat</i>
<i>Matt schwarz</i> |  |
|---|---|--|---|---|---|

Metallo / Metal / Métal / Metall

- | | | | | | |
|--|---|--|---|--|---|
| .09 Metallo bianco
<i>White Metal</i>
<i>Métal Blanc</i>
<i>Weiß Metall</i> |  | .17 Metallo antracite
<i>Dark grey metal</i>
<i>Métal Anthracite</i>
<i>Metall Anthrazit</i> |  | .18 Metallo nero
<i>Black Metal</i>
<i>Métal Noir</i>
<i>Schwarz Metall</i> |  |
| .21 Metallo sabbia
<i>Sandquarz metal</i>
<i>Métal Sable</i>
<i>Sand Metall</i> |  | .29 Metallo cromo
<i>Chromed metal</i>
<i>Métal Chromé</i>
<i>Chrom Metall</i> |  | .30 Metallo oro
<i>Gold colored metal</i>
<i>Métal Couleur</i>
<i>Gold Metall</i> |  |
| .32 Metallo satinato
<i>Brushed metal</i>
<i>Métal Brossé</i>
<i>Gebürstetem Metall</i> |  | .33 Metallo nichel nero
<i>Black nickel colored metal</i>
<i>Métal Couleur</i>
<i>Nickel noir</i> |  | .34 Metallo rame
<i>Copper colored metal</i>
<i>Métal cuivre</i>
<i>Kupfer Metall</i> |  |
| .35 Metallo bronzo
<i>Bronze Metal</i>
<i>Métal de bronze</i>
<i>Bronze Metall</i> |  | | | | |

Ceramica / Ceramic / Céramique / Keramik

- | | | | | | |
|---|---|--|---|--|---|
| .09 Ceramica bianco lucida
<i>Ceramic white glossy</i>
<i>Céramique Blanche Brillante</i>
<i>Keramik weiß glänzend</i> |  | .17 Ceramica antracite
<i>Ceramic Charcoal</i>
<i>Céramique Anthracite</i>
<i>Keramik Anthrazit</i> |  | .21 Ceramica sabbia
<i>Ceramic sand quartz</i>
<i>Céramique Sable</i>
<i>Sand Keramik</i> |  |
|---|---|--|---|--|---|

- | | |
|--|---|
| .26 Ceramica bianco matte
<i>Ceramic white matt</i>
<i>Céramique blanche mat</i>
<i>Weiß Keramik matt</i> |  |
|--|---|







Mattstone / Mattstone / Mattstone / Mattstone

- | | |
|---|---|
| .26 Mattstone
<i>Mattstone</i>
<i>Mattstone</i>
<i>Mattstone</i> |  |
|---|---|

Vetro / Glass / Verre / Glas

- | | | | | | |
|--|---|---|---|---|---|
| .29 Vetro foglia argento
<i>Silver leaf glass</i>
<i>Verre Feuille couleur argent</i>
<i>Blattsilber Glas</i> |  | .30 Vetro foglia oro
<i>Gold leaf glass</i>
<i>Verre feuille couleur or</i>
<i>Gold Blatt Silver</i> |  | .80 Vetro trasparente
<i>Clear glass</i>
<i>Verre Transparent</i>
<i>Transparent Glass</i> |  |
| .81 Vetro acidato
<i>Etched glass</i>
<i>Verre Satiné</i>
<i>Glas geätzt</i> |  | | | | |

Tessuto / Fabric Colour / Tissu / Stoff Farbe

- | | | | | | |
|---|---|---|---|---|---|
| .09 Bianco
<i>White</i>
<i>Blanc</i>
<i>Weiß</i> |  | .47 Grigio
<i>Grey</i>
<i>Gris</i>
<i>Grau</i> |  | .52 Tortora
<i>Dove-grey</i>
<i>Tourterelle</i>
<i>Turteltaube</i> |  |
| .52 Tabacco
<i>Tobacco</i>
<i>Tabac</i>
<i>Tabak</i> |  | .53 Antracite
<i>Anthracite</i>
<i>Anthracite</i>
<i>Anthrazit</i> |  | .58 Beige
<i>Beige</i>
<i>Beige</i>
<i>Brige</i> |  |

lineabeta®

Lineabeta SpA

36053 Gambellara VI - Italy
Strada Statale 11, Km 331
T. +39 0444 644644
F.+39 0444 644600
info@lineabeta.com

lineabeta.com



Art work: **Henry&Co. Design**

Illustration: **Antonella Manenti**

Rendering: **Studio Saxsi e Riccardo Urnato**

Printed in Italy: **Intergrafica Verona**

Ed.: **2017**

RINGRAZIAMENTI:

Questi strumenti non sarebbero mai stati realizzati senza la collaborazione delle persone che lavorano dentro e fuori Lineabeta. Grazie a tutti.

Un ringraziamento particolare a Carlo



